

MEMORY HiCORDER 8860-50, 8861-50

Recorders / Digital Oscilloscope

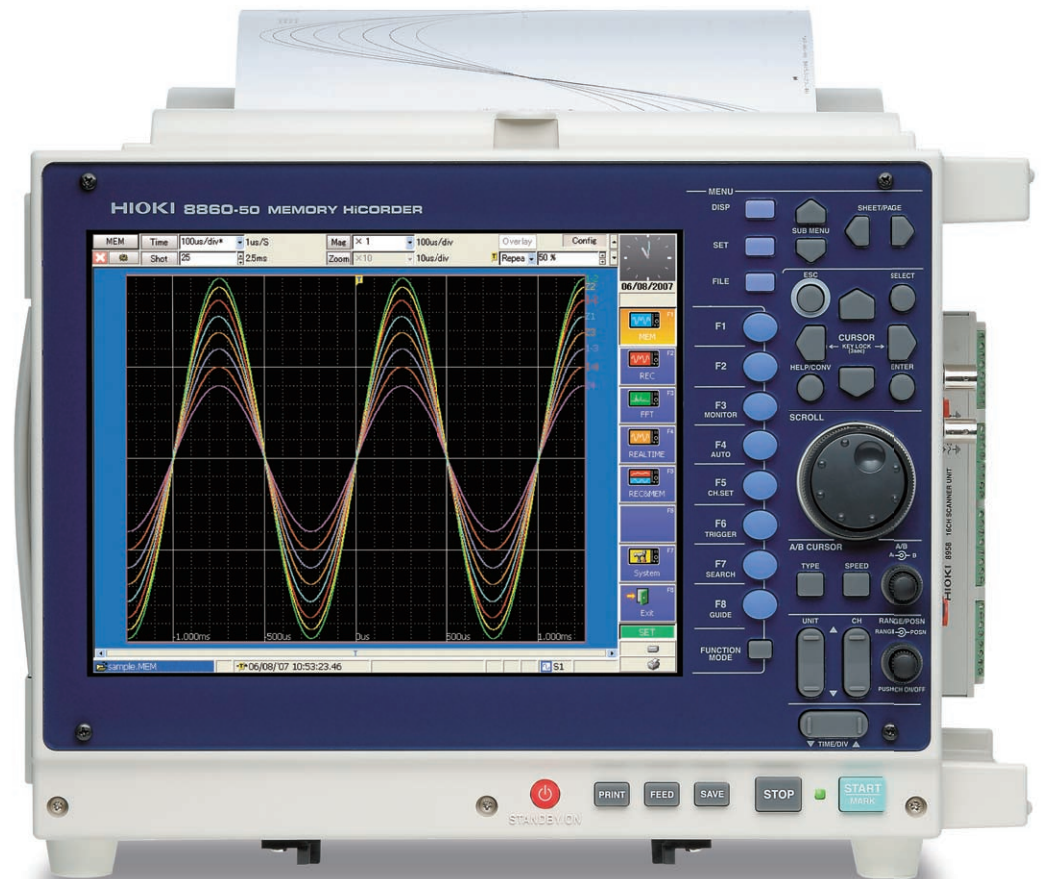

New REC&MEM Function New Recording Logger and Oscilloscope

The HIOKI MEMORY HiCORDER 8860 Series now sports vastly enhanced functionality. With new mouse and keyboard support, these models feature personal computer-like operability, accelerated by new internal high-speed hardware that provides simpler, faster operation. The Memory function monitors fast waveforms as easily as an oscilloscope while the Logger function records trend graphs in real time.

Convenience is improved by enhanced control via LAN and USB capabilities. A broad selection of plug-in front-end modules supports a wide variety of measurement objects. Abnormal phenomena are accurately captured with 20 MS/s sampling and 16-bit resolution on isolated inputs. Existing input modules for former 8860 models can be used as is.



ISO 9001
JMI-0216



ISO 14001
JQA-E-90091



www.hioki.com

HIOKI company overview, new products, environmental considerations and other information are available on our website.

As an Oscilloscope As a Data Logger Record Waveforms in Any Situation

Model 8860-50/8861-50 Series Debut!

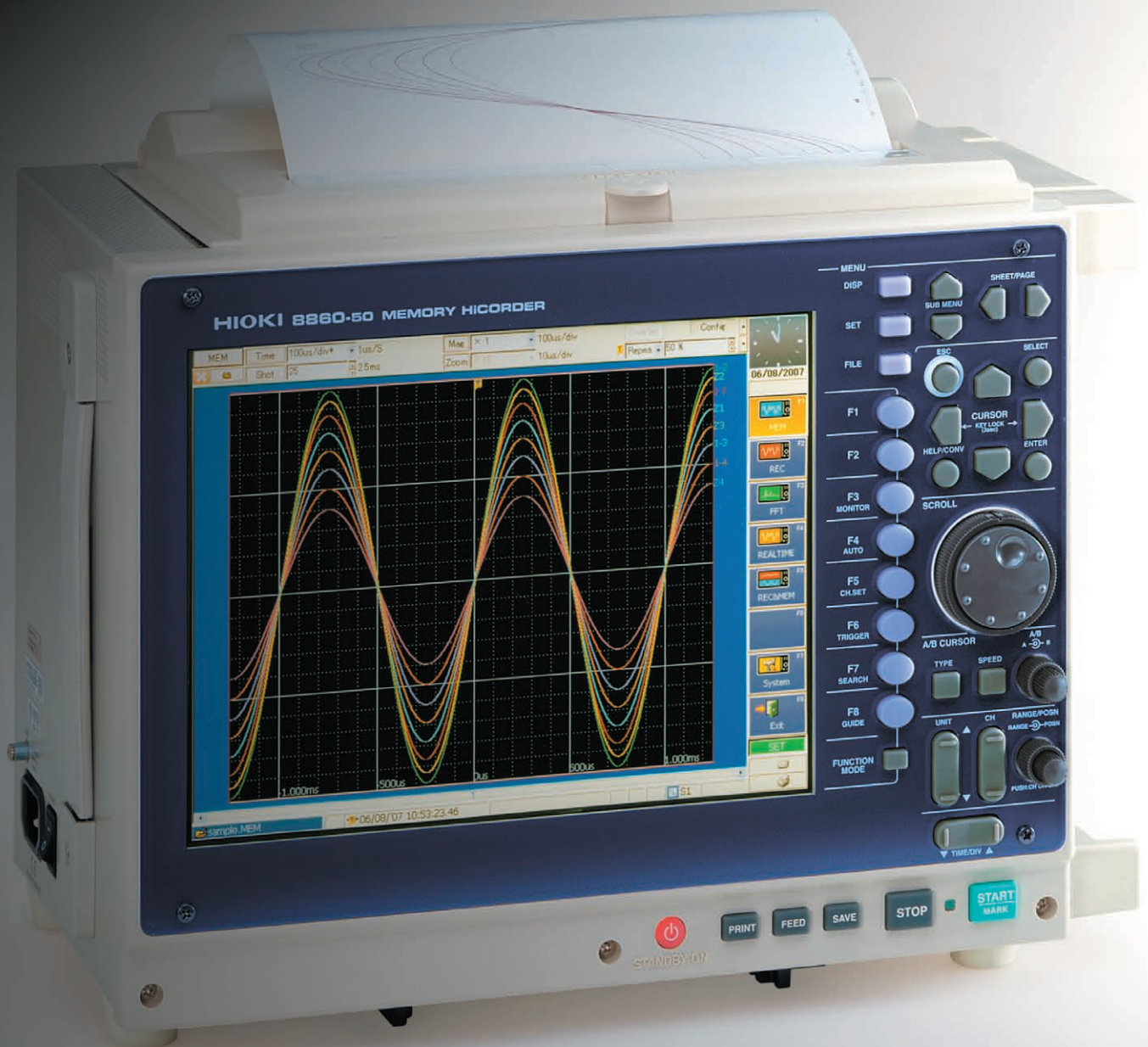

Capabilities and Features

20 MS/s high-speed sampling  See page 4



Up to 32 isolated input channels (high-speed signals)

Real-time saving to hard disk  See page 5

Dual-timebase sampling for simultaneous fast and slow monitoring  See page 6

Multi-channel logging on up to 128 channels (low-speed signals)  See page 6

Enhancements from Earlier Models 8860 and 8861

- A faster CPU greatly enhances instrument operability and response.
- Three USB 2.0 ports support a USB storage device along with mouse and keyboard.  See page 10
- New REC&MEM (Recorder and Memory) function.
Capture waveforms of high-speed transients while simultaneously recording at slow speed.  See page 5
- New LCD with wider viewing angle for easier waveform observation.
- Uses the same input modules as previous models.
- Supports the new high-voltage input module for measuring high voltage directly.  See page 4



8860-50 side view

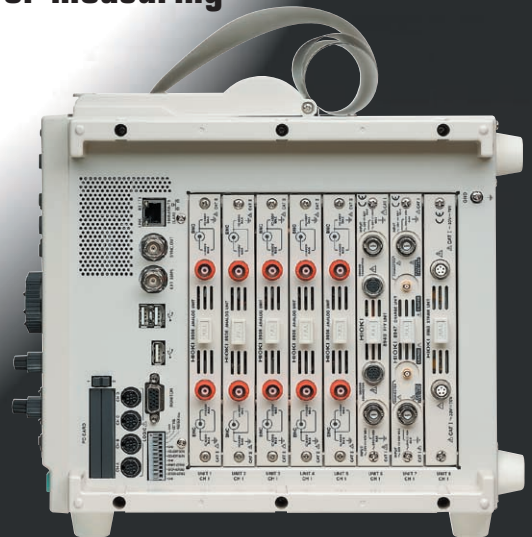

8861-50 side view

Reliably capture waveform anomalies buried within normal signals

- Memory (Digital Oscilloscope) Function -

Memory Function for High-Speed Waveform Monitoring

Using the same operating principle as a digital oscilloscope, data is recorded to the expanded internal memory at high speed. Sampling rate is up to 20 MS/s (50-ns period) for all channels simultaneously. Capture unpredictable operating anomalies and transient waveforms.

Records to Solid-State Memory

Because instruments that rely on disk access such as hard disk drives are susceptible to vibration, they are often unsuitable for on-board measurements. MEMORY HiCORDERs are preferable for on-board testing because they write data to solid-state memory with no moving parts. You can back up data to a PC Card or USB storage device when finished measuring. When the optional memory backup unit is installed, the instrument's internal memory data is preserved when power is turned off.

All Channels Isolated, 20 MS/s Sampling

Except when using the Scanner Module, every input channel has its own A/D converter. Because all channels are sampled simultaneously, transient waveforms can be easily observed along with signals. The Scanner Module switches all inputs through a single A/D converter, but even in that case, all channels are isolated.

External Sampling Input Capability

The sampling rate for memory recording can be synchronized to an external clock signal (up to 10 MS/s). So, for example, sampling can be synchronized to the rotation cycle of an engine.

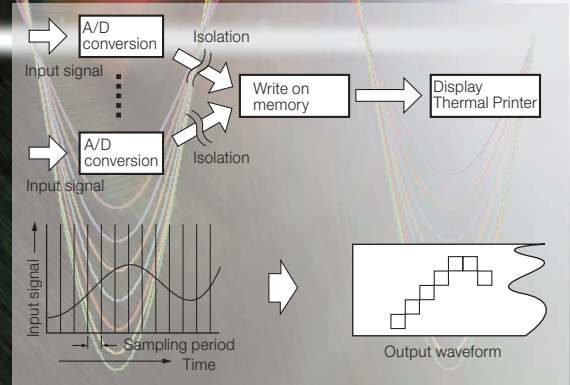

Large Capacity Internal Memory

Both high-speed write capability and a large memory capacity are provided to support high-speed sampling. Total memory capacity ranges from 32 megawords to 1 gigaword, enabling capture of waveform peaks by high-speed sampling, as well as long-term recording and long-period waveform capture. (Model 8861-50 provides twice the memory capacity, but with the same recording time limits.)

Internal Memory Division (Segmentation) Function

Internal memory can be segmented for use into 4,096 blocks. By using "sequential save" to write data to the segmented memory, the waveform in any block can be overlaid with that in a reference block for comparison.

An Actual Waveform Measurement Example

For operational analysis of an inverter, the waveforms of the high frequency switched carrier and the low frequency fundamental both need to be observed. High-speed sampling, long-term memory recording and input isolation make these observations possible. Various HIOKI non-contact clamp-on sensors capable of measuring up to HF ranges can be used to observe current waveforms.

CLAMP ON PROBE 3270 Series provides flat electrical characteristics for observing current waveforms over a remarkably broad range of amplitudes from mA order to 500 A at frequencies from DC to HF.

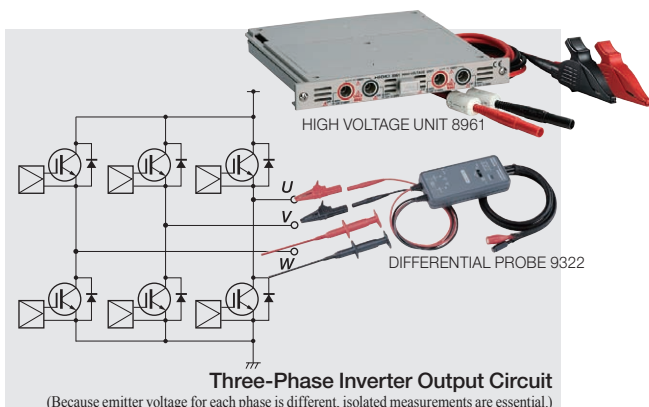

High-Voltage Measurement

Measuring in situations where high voltage exists between channels, such as three-phase inverters, requires a measurement instrument that has all input channels isolated. In addition, when measuring signals such as those of switching circuits that include common-mode voltage with a high-frequency component, the isolated circuit's common-mode frequency rejection characteristics can greatly affect measurements. To measure these kinds of voltages, you can use the HIGH VOLTAGE UNIT 8961 or the optional DIFFERENTIAL PROBE 9322 for CAT III 600-volt AC and DC maximum rated voltage to earth.

Capture High-Speed Signals by Triggering During Slow Recording

- New REC&MEM Function and Real-Time Saving -

Simultaneous Long-Term Monitoring and Transient Recording (REC&MEM)

■ Transient waveform recording that is impossible with a pen recorder

The new REC&MEM function can record high-speed waveforms such as intermittent noise by applying a trigger while recording long-term fluctuations just like a pen recorder. This type of measurement previously required choosing between the Recorder function (for slow trend graph recording), or the Memory function (for high-speed oscilloscope-style recording). Now both types of waveforms can be recorded simultaneously using the REC&MEM function.

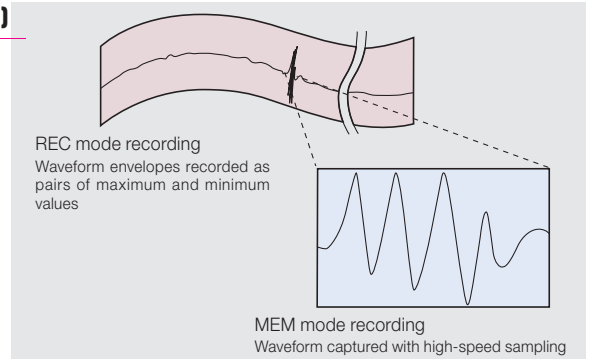

■ Maximum recording time for REC&MEM function (Recorder waveform)

- The setting range depends on installed memory capacity, whether Memory Division is enabled, and whether 16-Ch Scanner Unit 8958 is installed.
- Recording length "Continuous" is not available with 100 to 200 ms/div timebase setting, and with the printer enabled.
- Timebase settings from 10 ms/div to 1 s/div are not available when using A6 Printer Unit 8995-01 and numerical value printing.
- When the sampling period for Recording and Memory recording is set at the same time.
- Operation cannot be guaranteed when the time axis is longer than one year.

Without Scanner Unit 8958		Memory capacity 2,000 div	Memory capacity 10,000 div	Memory capacity 40,000 div	Memory capacity 80,000 div
REC Timebase	Sampling Period				
100 ms/DIV	100ns	3min 20s	16min 40s	1h 06min 40s	2h 13min 20s
30 min/DIV	to	41d 16h	208d 08h	- abbreviated -	- abbreviated -
1 hr/DIV	to	83d 08h	- abbreviated -	- abbreviated -	- abbreviated -

With Scanner Unit 8958		Memory capacity 32 M-words	Memory capacity 128 M-words	Memory capacity 512 M-words	Memory capacity 1 G-word
REC Timebase	Sampling Period				
100 ms/DIV	100ns	50s	3min 20s	16min 40s	33min 20s
30 min/DIV	to	10d 10h	41d 16h	208d 08h	- omitted -
1 hr/DIV	to	20d 02h	83d 08h	- abbreviated -	- abbreviated -

■ Operating Principle of the Recorder Function

With the Recorder function, only maximum and minimum values of the data sampled within the specified timebase are written to memory, so each recorded data point consists of a pair of values, with 100 such points recorded for each waveform timebase division.

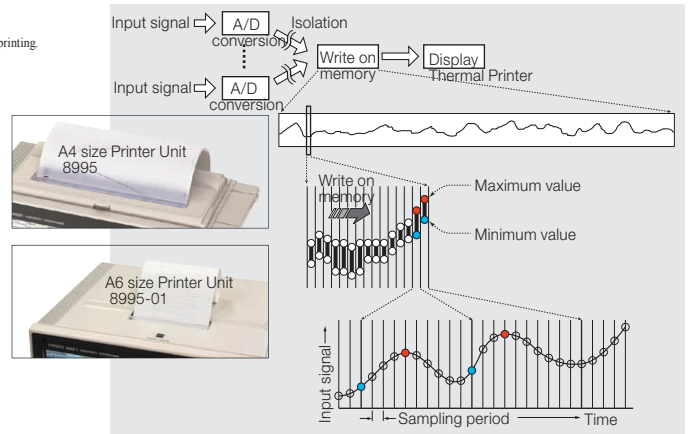

Because of this, the volume of recorded data is compressed while following steep fluctuations of the measured input voltage.

Note: When data recorded with the Recorder function is viewed on a PC, both minimum and maximum values appear as a time series of data points.

■ Maximum recording time for REC&MEM function (Memory waveform)

- The setting range depends on installed memory capacity, and whether Memory Division is enabled. Maximum recording length is available when Memory Division is disabled.
- Presence of 16-Ch Scanner Unit 8958 has no effect (scanner module signals are not written to internal memory for Memory waveforms).
- Operation cannot be guaranteed when the time axis is longer than one year.



- Minimum recording length is available when Memory Division is set to 1,024 blocks.

Memory Division is enabled		Memory capacity 32 M-words	Memory capacity 128 M-words	Memory capacity 512 M-words	Memory capacity 1 G-word
MEM Timebase	Sampling Period				
10 μs/DIV	100ns	50ms	200ms	800ms	1.6s
20 μs/DIV	200ns	100ms	400ms	1.6s	3.2s
50 μs/DIV	500ns	250ms	1s	4s	8s
5 min/DIV	3.0s	17d 08h 40min	69d 10h 40min	277d 18h 40min	- abbreviated -

With Memory Division 1024 blocks		Memory capacity 32 M-words	Memory capacity 128 M-words	Memory capacity 512 M-words	Memory capacity 1 G-word
MEM Timebase	Sampling Period				
10 μs/DIV	100ns	30μs	150μs	600μs	1.4ms
20 μs/DIV	200ns	60μs	300μs	1.2ms	2.8ms
50 μs/DIV	500ns	150μs	750μs	3ms	7ms
5 min/DIV	3.0s	15min	1h 15min	5h 00min	11h 40min

Recording Directly to Hard Disk or Other Storage Media (Real-Time Save)

■ Recording an Entire Waveform Anomaly

The Real-Time Save function writes measurement data to the specified destination during measurement, enabling long-term measurements independent of the instrument's installed memory capacity. The destination storage media may be the internal hard disk, a PC Card or a shared network folder.

Simultaneously, overall measurement data (the whole waveform) is recorded in the instrument's internal memory, which is then saved to the storage media when measurement is finished. For analysis, specify the range to be analyzed from the overall waveform data, and reload it. The reloaded data is used with the Memory function for waveform and numerical calculations, or with the FFT function for FFT analysis.

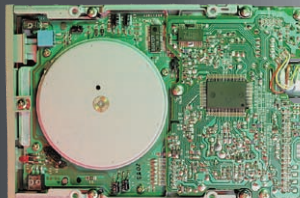

■ Maximum recording time for REC&MEM function

Timebase	Sampling Period	No. of recording channels		Max. recording time (typical)	
		HDD	PC card	HDD	PC card (512 MB)
5μs/DIV to 50μs/DIV	- abbreviated -	not applicable	not applicable	not applicable	not applicable
100 μs/DIV	1μs	1ch	not applicable	8h 19min 17s	not applicable
200 μs/DIV	2μs	1ch	not applicable	16h 38min 34s	not applicable
500 μs/DIV	5μs	2ch	1ch	20h 48min 10s	20min 55s
1 ms/DIV	10μs	4ch	2ch	20h 48min 10s	20min 40s
2 ms/DIV	20μs	10ch	4ch	16h 38min 20s	20min 20s
5 ms/DIV	50μs	24ch	8ch	17h 17min 30s	24min 20s
10 ms/DIV	100μs	33ch	20ch	1day 1h 8min 20s	16min 40s
20 ms/DIV	200μs	33ch	33ch	2days 2h 16min 40s	16min 40s
50 ms/DIV to 5 min/DIV	- abbreviated -	- abbreviated -	- abbreviated -	- abbreviated -	- abbreviated -

- Conditions: the hard disk or PC Card have just been formatted, and any recording length setting is set to maximum. The timebase of the whole (compressed) waveform is set automatically, and the upper limit of recording time is one year.
- Recording time depends on the formatted capacity of the recording media and its available capacity, with the above being just one example.
- Recordable time for storage media depends on the instrument's installed memory capacity, and the total and available capacity of the media. The whole waveform is displayed in real time (and printing is disabled).

Note: Scanner Unit 8958 is not used.

3μs	1.4375mV 3.3375 V	1.4375mV 3.325 V	1.5mV 3.325 V	1.375mV 3.3375 V	1.4375mV 3.3375 V	1.4375mV 3.3375 V	1.4375mV 3.3375 V
4μs	1.75mV 3.4375 V	1.75mV 3.425 V	1.8125mV 3.425 V	1.6875mV 3.4375 V	1.75mV 3.4375 V	1.75mV 3.4375 V	1.75mV 3.4375 V
5μs	2.4375mV 3.525 V	2.4375mV 3.5125 V	2.5mV 3.5125 V	2.375mV 3.525 V	2.4375mV 3.525 V	2.4375mV 3.525 V	2.4375mV 3.525 V
6μs	2.8125mV 3.5875 V	2.8125mV 3.575 V	2.875mV 3.575 V	2.75mV 3.5875 V	2.8125mV 3.5875 V	2.8125mV 3.5875 V	2.8125mV 3.5875 V
7μs	3.3125mV 3.675 V	3.3125mV 3.6625 V	3.375mV 3.6625 V	3.25mV 3.675 V	3.3125mV 3.675 V	3.3125mV 3.675 V	3.3125mV 3.675 V

The Next Generation Hybrid Recorder

- A single instrument provides both oscilloscope and data logger functions -

Installing a Scanner Module Creates a Multi-Channel Data Logger

Recording slowly changing physical values such as temperature has been performed by plotting recorders and hybrid recorders (combined numerical value and analog graph recording), and is currently performed by data loggers. On the other hand, for high-speed waveform observation, only an oscilloscope (or MEMORY HiCORDER) can be used. However, because the demands of measurement sites can vary, having both of these functions in a single instrument can be advantageous.

MEMORY HiCORDER Models 8860-50 and 8861-50 and Scanner Unit 8958 are the answer to customers' needs.

■ Economical Cost per Channel

The Scanner Module switches 16 input channels through one A/D converter. Of course all channels are isolated. Cost per channel is thereby remarkably reduced when compared to systems that include an A/D converter for every input channel. Installing four Scanner Modules in the 8860-50 provides 64 measurement channels, and installing eight Scanner Modules in the 8861-50 provides 128 measurement channels.

■ Dual-Timebase Sampling at High and Low Speeds

Depending on customers' applications, there are cases in which high-speed signals need to be captured as waveforms while measuring multiple channels with a Scanner Module. Both types of signals can be measured by using a scanner module together with a common high-speed analog module, and recording with two different timebases. Two waveforms are displayed and can be monitored on the same time axis.

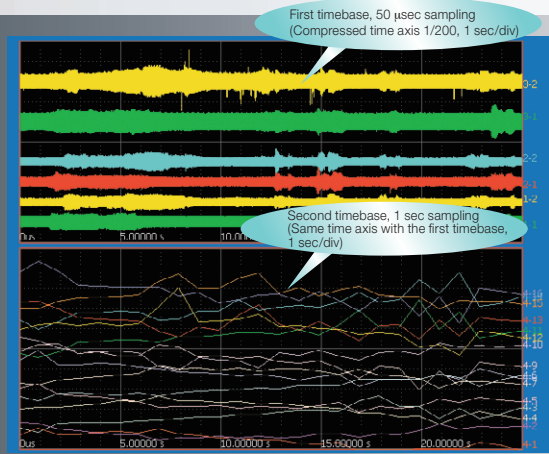

Time	1-1	1-2	2-1	2-2	3-1	3-2
0us	0.200mV	-0.200mV	0.625mV	0.625mV	-0.775mV	2.0437mV
40us	1.500mV	1.500mV	1.437mV	1.437mV	3.437mV	3.0437mV
100us	-1.700mV	-1.700mV	1.437mV	1.437mV	3.800mV	3.3125mV
150us	1.000mV	1.000mV	1.437mV	1.437mV	4.437mV	3.0437mV
200us	-1.500mV	-1.500mV	1.437mV	1.437mV	4.437mV	3.3125mV
250us	1.500mV	1.500mV	1.437mV	1.437mV	4.437mV	3.0437mV
300us	-1.500mV	-1.500mV	1.437mV	1.437mV	4.437mV	3.3125mV
350us	1.500mV	1.500mV	1.437mV	1.437mV	4.437mV	3.0437mV
400us	-1.500mV	-1.500mV	1.437mV	1.437mV	4.437mV	3.3125mV
450us	1.500mV	1.500mV	1.437mV	1.437mV	4.437mV	3.0437mV
500us	-1.500mV	-1.500mV	1.437mV	1.437mV	4.437mV	3.3125mV
550us	1.500mV	1.500mV	1.437mV	1.437mV	4.437mV	3.0437mV
600us	-1.500mV	-1.500mV	1.437mV	1.437mV	4.437mV	3.3125mV
650us	1.500mV	1.500mV	1.437mV	1.437mV	4.437mV	3.0437mV
700us	-1.500mV	-1.500mV	1.437mV	1.437mV	4.437mV	3.3125mV
750us	1.500mV	1.500mV	1.437mV	1.437mV	4.437mV	3.0437mV
800us	-1.500mV	-1.500mV	1.437mV	1.437mV	4.437mV	3.3125mV
850us	1.500mV	1.500mV	1.437mV	1.437mV	4.437mV	3.0437mV
900us	-1.500mV	-1.500mV	1.437mV	1.437mV	4.437mV	3.3125mV
950us	1.500mV	1.500mV	1.437mV	1.437mV	4.437mV	3.0437mV
1000us	-1.500mV	-1.500mV	1.437mV	1.437mV	4.437mV	3.3125mV
1050ms	1.710mV	0.850mV	1.688mV	1.430mV	2.481mV	3.181mV
110ms	1.530mV	1.330mV	1.500mV	1.375mV	2.619mV	3.043mV
115ms	1.380mV	0.900mV	1.688mV	1.310mV	2.562mV	2.7813mV
120ms	1.250mV	1.350mV	1.430mV	1.310mV	2.619mV	2.619mV
125ms	1.650mV	1.400mV	1.430mV	1.410mV	2.619mV	2.619mV
130ms	1.650mV	1.250mV	1.560mV	1.438mV	1.859mV	1.400mV
135ms	1.250mV	1.400mV	1.430mV	1.410mV	2.619mV	2.619mV
140ms	1.100mV	0.950mV	1.688mV	1.500mV	1.688mV	2.461mV

Sheet Display Function

The Sheet function has been introduced to support multi-channel measurements (each sheet shows 32 channels). Different display formats can be selected for each sheet, so that each sheet can be assigned and analyzed for a particular application.

The waveform scrolling direction can be switched between vertical and horizontal. You can also view a continuously scrollable display to confirm a whole long-term waveform without time-axis compression, while simultaneously displaying time series' and X-Y plots.

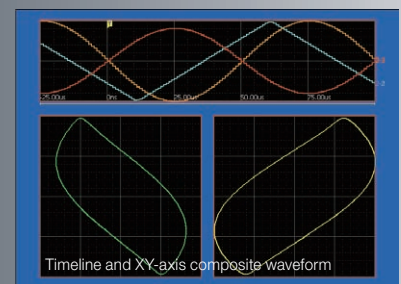
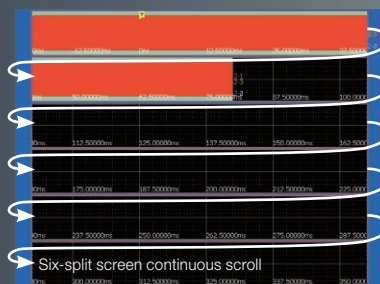
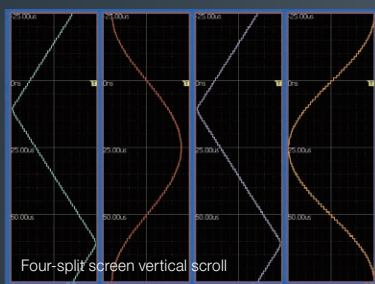

Waveform Observation While Recording

■ Changing Compression and Zooming While Measuring

Models 8860-50 and 8861-50 support changing the compression ratio, turning the zoom function on and off, and scroll-back display while measuring, so you can view and analyze existing measurement data without having to wait for the measurement process to finish.

■ Scroll-Back Display

An earlier portion of the waveform can be viewed without interrupt recording. This function automatically displays earlier parts of the waveform just by turning the Scroll knob counterclockwise. Click the Scroll Trace button on the screen, to return the display to the current waveform position.

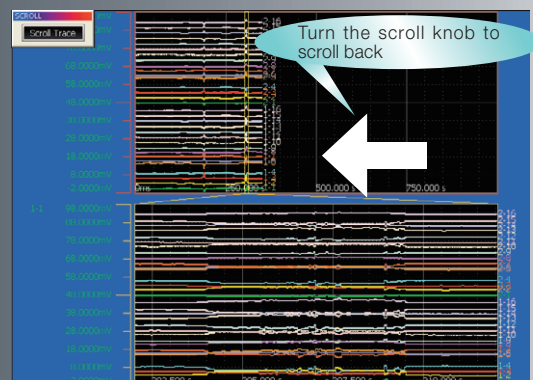

Accurately capture waveforms with diverse parameters

- Advanced trigger function -

Trigger during capturing and search after capturing

The trigger function allows you to set diverse parameters to detect a particular waveform anomaly during capturing. Setting the pre-trigger mode allows you to monitor the pre-trigger waveform. This is useful for analyzing the cause of the anomaly.

On the other hand, the search function allows you to detect an anomaly after all data is captured. This allows you to search for and display an anomaly in the same manner as with the trigger function.

When a waveform is unpredictable and setting a parameter during measurement is difficult, it is recommended to use the search function to locate an anomaly after capturing.

■ Stop trigger for the MEM function

Unlike with conventional MEMORY HiCORDERs, a stop trigger is supported. This enables the timing of measurement to be controlled for both the MEM and REC functions. This also allows you to set Start or Stop independently for each trigger source, thus enabling the timing of measurement to be controlled in a variety of combinations. (Start or Stop trigger can also be set to the logical source.)

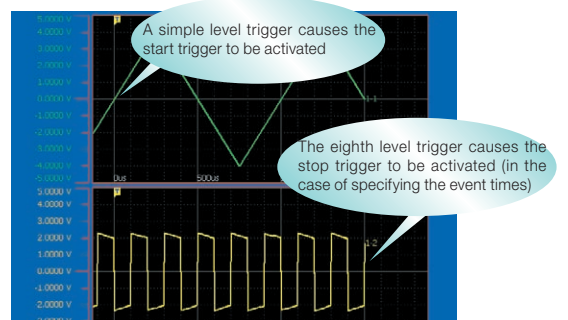

■ Capture a sudden power loss with the drop trigger

Set the voltage drop trigger to capture a sudden power loss resulting from a blackout caused by lighting or a circuit breaker tripping.

Set the window out trigger to capture an impulse noise or surge noise (voltage swell) caused by, for example, the solenoid opening and closing.

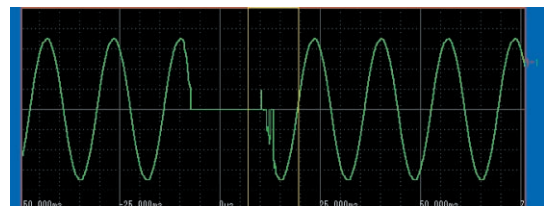

■ Slope trigger

Unlike with conventional MEMORY HiCORDERs, a slope trigger is supported. This allows you to monitor a noise superimposed on periodic waveforms such as a power waveform. This also allows you to monitor a rapid change in temperature with the amount of change in slope instead of level.

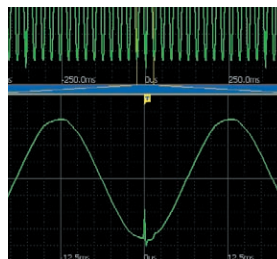

Power waveform noise



Power waveform noise

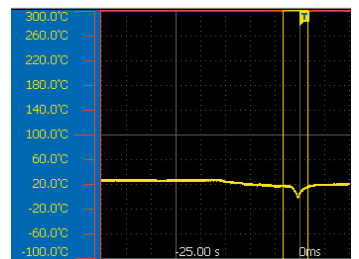

Rapid change in temperature

■ Edge detection and level detection of the logic trigger

Unlike with conventional MEMORY HiCORDERs supporting only edge detection, the Models 8860-50 and 8861-50 supports level detection of the logic trigger. This function causes the trigger to be activated when a specified pattern occurs, even if the logic pattern condition is not met after the start of measurement.

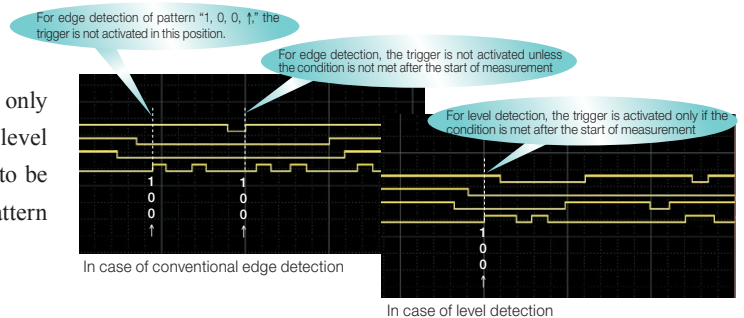

In case of conventional edge detection

In case of level detection

■ Set the event times independently for each trigger source

* For the analog trigger only

Unlike with conventional MEMORY HiCORDERs, this allows you to set the event times independently for each trigger source, thus enabling the setting of trigger conditions in a variety of combinations.

Set multiple triggers on a single channel

Unlike with conventional MEMORY HiCORDERs, the 8860 series allows you to set multiple trigger parameters on a particular single channel. This allows you to set, for example, the glitch trigger, level trigger, window-out trigger, voltage drop trigger, window-in trigger, and on the same input waveform to monitor it. (8 parameters in the 8860-50 and 16 parameters in the 8861-50 can be set.)

No.	Type	Ch	Level	Slope	Filter	Parameters
1	Glitch	1-1		OV	T	Width: 100ns
2	Level	1-1		OV	T	Off (0s)
3	Win-Out	1-1			Off (0s)	Upper: 142.4V Lower: -142.4V Freq: 60Hz
4	Drop	1-1		139.6V		
5	Win-In	1-1			Off (0s)	Upper: 52V Lower: -8V

No.	Type	Ch	Level	Slope	Filter	Parameters	Parameters
1	Level	1-2	OV	T	Off	Event: 1 Timing: Start	
2	Win-In	1-2			Off	Upper: 200mV Lower: -200mV	Event: 2 Timing: Start
3	Win-Out	2-1			Off	Upper: 4mV Lower: -4mV	Event: 3 Timing: Start
4	Por-In	1-1	OV	T	Off	Upper: 20us Lower: 0s	Event: 4 Timing: Start
5	Por-Out	1-1	OV	T	Off	Upper: 20us Lower: 0s	Event: 5 Timing: Start

The trigger event times for the trigger source is set to 5.

Convert the time domain to the frequency domain for analysis

- FFT analysis function -

FFT analysis function

The single-channel FFT function is used in spectrum analysis. The two-channel FFT function analyzes transfer functions. The octave analysis function is used in acoustic analysis. The signal source for FFT analysis is a section obtained from the waveforms captured in the MEM function (the required number of pieces of data for FFT analysis are 1000 to 20,000 points). The calculation speed for the same condition (when performing the most time-consuming analysis) is about ten times faster than with the conventional Model 8855.

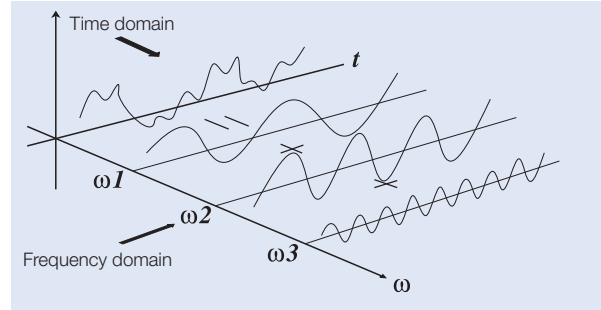

Simultaneously perform up to 16 calculations

Unlike with the conventional HIOKI 8855 and 8841 models that allow for the simultaneous performing of up to two calculations, the 8860-50 and 8861-50 models allow for the simultaneous performing of up to eight (four times more) FFT calculations for analysis. Furthermore, the analysis channel can be selected independently.

No.	Analyze	Col.	Parameter	Ch1	Ch2	Yaxis	Xaxis
F1	Storage Waveform	▲		1- 1		Lin-Mag	Linear
F2	Linear Spectrum	▲	Normal	1- 1		Lin-Mag	Linear
F3	RMS Spectrum	▲		1- 1		Lin-Mag	Linear
F4	Power Spectrum	▲		1- 1		Lin-Mag	Linear
F5	Power Spectrum	▲		1- 1		Lin-Mag	Linear
F6	Auto Correlation	▲		1- 1		Lin-Mag	Linear
F7	Histogram	▲		1- 1		Lin-Mag	Linear
F8	1/1 Octave	▲	Filter: Normal	1- 1		Lin-Mag	Log

Split screen (a total of 14 patterns)

You can select a split screen format according to your needs. For example, the MEM and REC functions allow you to select a different split screen format independently for each sheet. Unlike with, for example, the conventional 8855 and 8841 models, a function to display superimposed graphs is also supported (however, the function depends on the analysis mode).

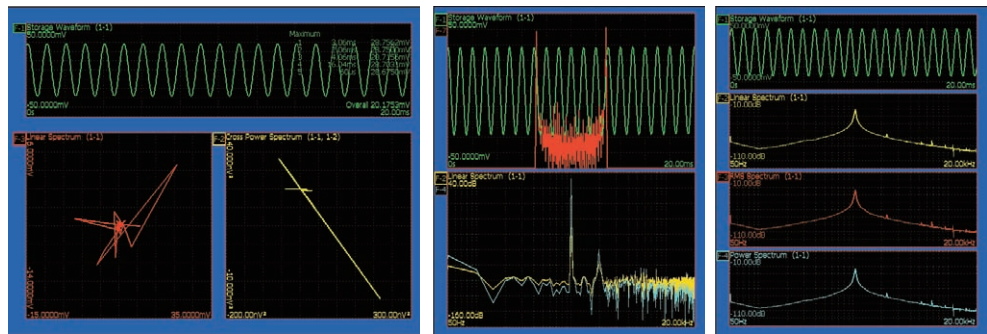

A variety of window functions

Unlike with the conventional 8855 and 8841 models that support only the three window function options "Rectangular," "Hanning," and "Exponential," the 8860-50 and 8861-50 models include four additional options, thus enabling you to select a window function from a total of seven options. Furthermore, a difference in calculation results of line spectrum between other companies' FFT analyzers and HIOKI's analyzer can be compensated by selecting the energy attenuation compensation method when using a window function.

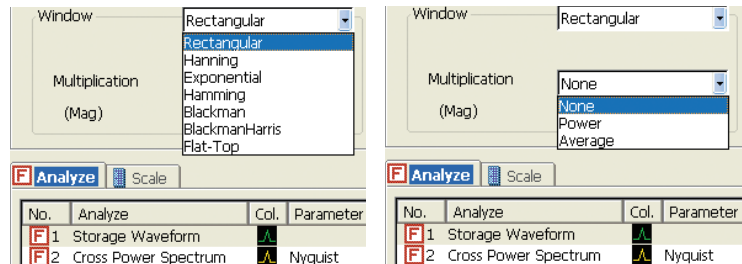

Phase Highlight Display

Phase Highlight emphasizes on the display only those parts of a waveform that exceed a certain level, in order to acquire a power spectrum in the midst of phase calculation. The figure shows power and phase spectra at the same time when the highlighted display is enabled, so you can easily see important parts of the waveform that are normally difficult to see because they appear like noise.

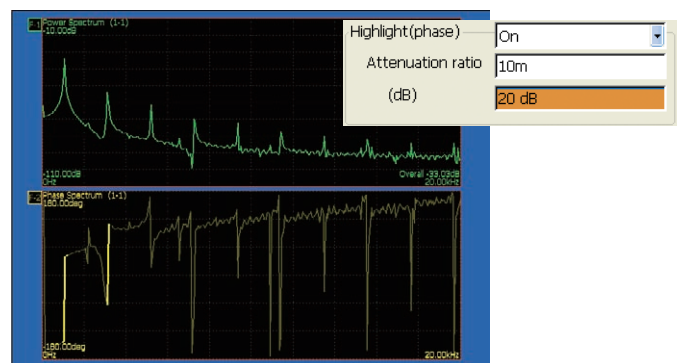

Change the settings on the DISP screen

The dialog bar on the top of the DISP screen (waveform monitoring screen) allows you to change the settings. The frequency resolution and capture time are also displayed.

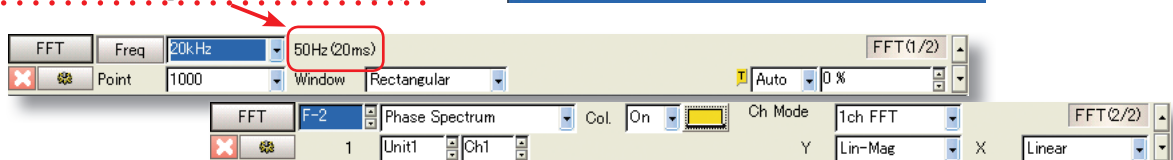

Perform FFT calculation on the waveform from the MEM function

When performing FFT analysis on the data obtained by measurement with the MEM function, you can use the jog shuttle to specify an analysis point and view the calculation results on the same screen. Unlike with the conventional 8855 and 8841 models, you do not need to switch between the MEM function and FFT function screens to set the starting point of calculation. Furthermore, the display of “Raw Data” obtained by measurement with the MEM function and the calculation results of “Storage Waveform” on the same screen allows you to view the effect of the window function and the spectrum waveform on the same window, thus greatly enhancing operability for analysis.

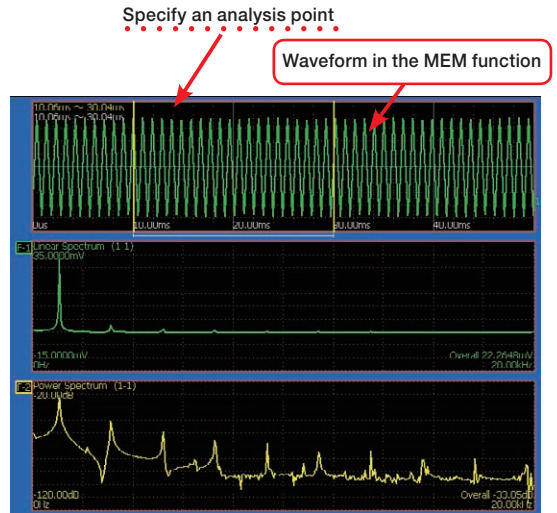

Rich Analysis Capabilities

Power Spectrum Density and LPC Analysis have been added to the calculation selections, for measuring power spectrum per Hz and spectral envelopes. As for calculation settings, former concepts such as “Channel Modes” have been eliminated, and channel settings are now automatically set according to the selected calculation type, eliminating otherwise complex settings.

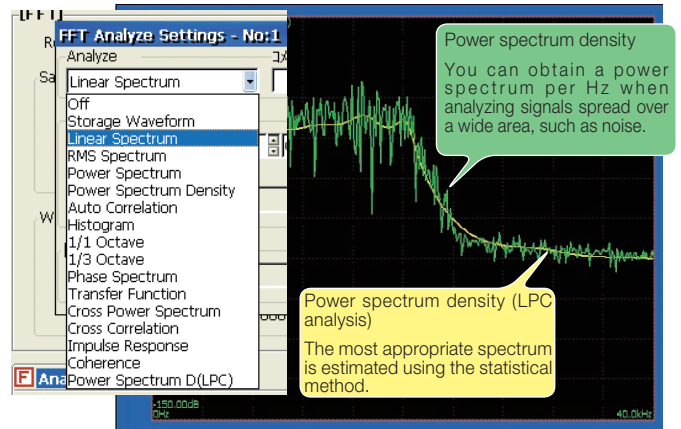

Change the count of calculation points and perform re-calculation after measurement ends

After measurement is performed using less calculation points, you can change the point count and perform re-analysis. For example, if you perform measurement using 1,000 calculation points, you can then convert point count to 20,000 to perform re-analysis on the data. In this case, the frequency resolution increases 10 times. Needless to say, you can convert the point count to 1,000 to perform re-analysis on the data obtained by performing measurement using 20,000 points.

* Re-calculation by changing the point count cannot be performed when Mean Frequency is set to ON.

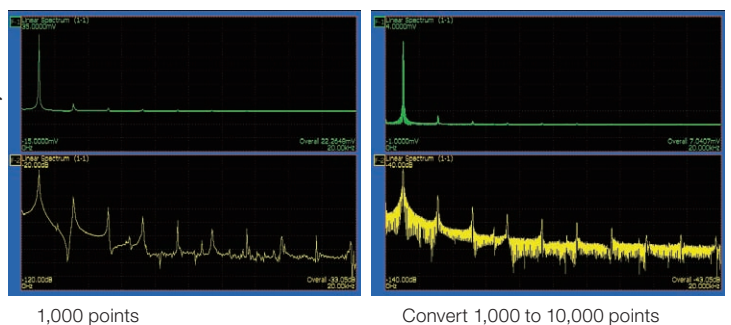

Scaling in “dB”

The long desired capability to scale in dB is supported. You no longer need to perform logarithmic calculation holding a calculator in one hand. The 8860-50 and 8861-50 models allow you to enter the overall value (sum of power spectrum values) in dB, thus making scaling easier. This enables signals to be easily read directly from, for example, a noise meter.

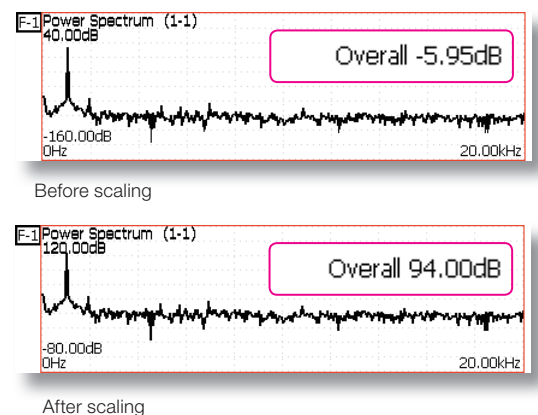
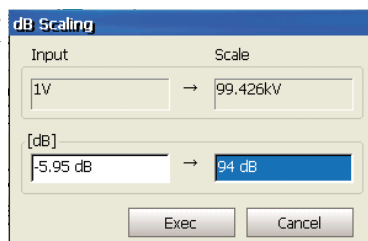

Remote control with the Internet browser

- LAN/USB, calculation function -

Remote control and automatic saving to a shared folder

The 8860 series allows for remote control using the Internet browser on the computer. When you register access to a shared folder on a computer on the network, you can store and load data to and from the shared folder on the 8860-50 or the 8861-50 file screen.

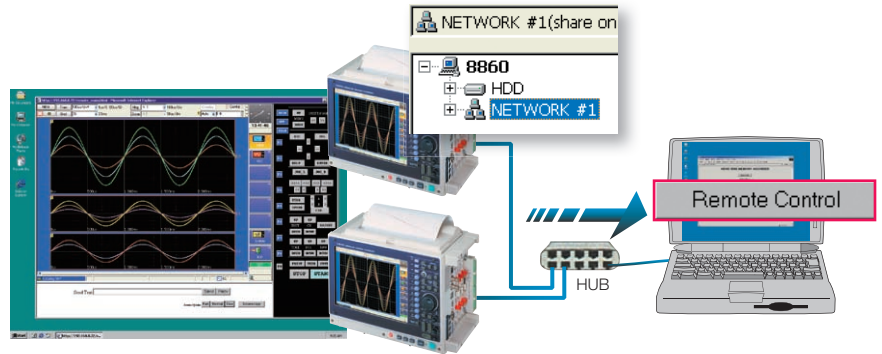

To access the shared folder:

Enter the host name of the computer on the file screen of the 8860-50, enter the user name and password in the account field, and then select the folder you want to share.

USB Mouse and keyboard connectivity

With the Windows-style interface, you can easily make settings and adjustments with the click of a mouse, and enter text and other comments with a keyboard as you would on a common PC.

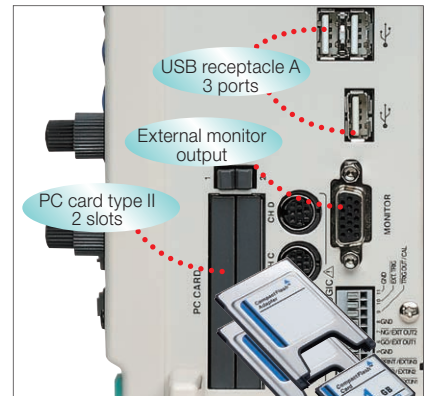
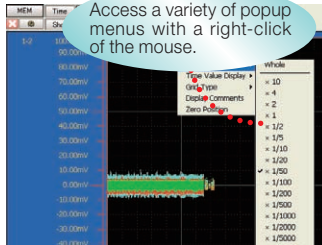

USB Ports and External Monitor Output

Three USB 2.0 ports are now provided to support commonly available PC peripherals. A VGA D-sub output connector is also included to support viewing the measurement screen on an external monitor.

Automatic saving during measurement

Unlike with conventional MEMORY HiCORDERS, the 8860 series allows automatic saving during measurement.

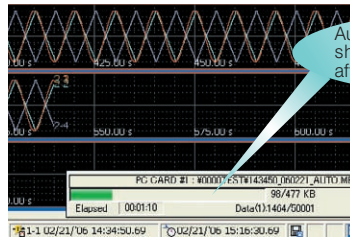

Redundancy against errors in the storage destination

The 8860 series allows you to set up to two storage destinations. Even if, for example, an overflow error occurs on a PC card during automatic saving, switching to the second backup storage destination takes place automatically to ensure saving continues.

Restrictions

Automatic saving during measurement is restricted to 1ms/division or more of the time axis. Also, restrictions to the time axis settings differ depending on the scanner module, number of channels, storage media, and setting conditions for real-time printing.

Set 16 groups of numerical calculations

Unlike with conventional MEMORY HiCORDERS, the 8860 series allows you to set 16 groups of numerical calculations. Furthermore, each group allows you to select 16 calculation items from a total of 19. The SUB MENU screen of the waveform screen also allows you to view and change the numerical calculation settings and perform recalculation. This enables the settings of calculations in each group on the waveform screen to be changed and monitored, thus enhancing operability.

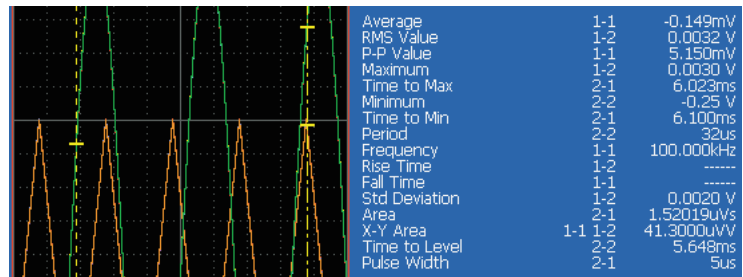

Simultaneously display timeline and XY-axis composite waveforms

The 8860 series uses a split screen to support the simultaneous display of "timeline waveform" and "XY-axis composite waveform." Any channel can be set to the X-axis and Y-axis. The MEM function supports XY-axis waveforms. Models 8860-50 and 8861-50 can display sixteen X-Y plots simultaneously.

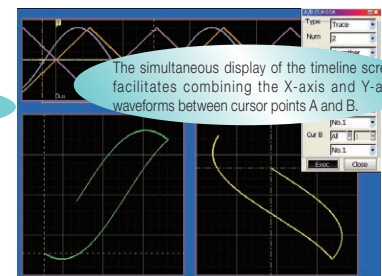
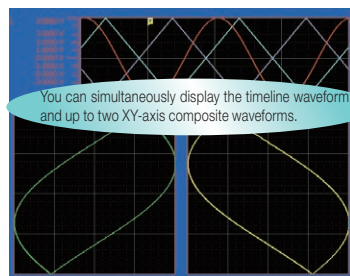

■ Main unit Specifications

Basic specifications	8860-50 (max. 4 input modules)	8861-50 (max. 8 input modules)
Input type/number of channels	Plug-in input modules Max. 16 analog channels (max. 64 channels with scanner unit) + 16 logic channels (standard configuration)	Plug-in input modules Max. 32 analog channels (max. 128 channels with scanner unit) + 16 logic channels (standard configuration)
Measurement functions	MEM (high-speed recording) REC (real-time recording) REC & MEM (real-time recording + high-speed recording) FFT (frequency analysis) Real-time Save (records directly to storage media)	
Maximum sampling rate	20 MS/second (50 ns, all channels simultaneously, using the ANALOG UNIT 8956) External sampling (10 MS/second, 100 ns)	
Types of measurement signals	1 unit: Voltage 2ch, 20 MS/s, 12-bit resolution (8956) 1 unit: Voltage 2ch, 2 MS/s, 16-bit resolution (8957) 1 unit: Voltage / Thermocouple scan 16ch, max. 50 ms refresh rate, 1/1000 of range resolution for temperature axis - (8958) 1 unit: Voltage / RMS, 1 MS/s, 12-bit resolution (8959) 1 unit: Voltage / RMS, 2 MS/s, 16-bit resolution (8961) 1 unit: Voltage 2ch, 1 MS/s, 12-bit resolution (8936/8938) 1 unit: Voltage / Thermocouple 2ch, 4 kS/s, 12-bit resolution (8937) 1 unit: Strain gauge 2ch, 1 MS/s, 12-bit resolution (8939) 1 unit: Strain gauge 2ch, 200 kS/s, 16-bit resolution (8960) 1 unit: Frequency / Integration / Current / Voltage 2ch, 1 MS/s, 12-bit resolution (8940) 1 unit: Accelerometer 2ch, 1 MS/s, 12-bit resolution (8947) 1 unit: Voltage 4ch, 1 MS/s, 12-bit resolution (8946)	
Direct access internal memory	32 Mega-words (MEMORY BOARD 9715-50 × 1) (analog 12-bit + logic 4-bit) × 32 Mega-words/ch (using 1 channel) to (analog 12-bit + logic 4-bit) × 2 Mega-words/ch (using 16 channels)	64 Mega-words (MEMORY BOARD 9715-50 × 2) (analog 12-bit + logic 4-bit) × 32 Mega-words/ch (using 2 channels) to (analog 12-bit + logic 4-bit) × 2 Mega-words/ch (using 32 channels)
<small>*1 Factory installation only: select 1 board for the 8860-50, and 2 of the same capacity for the 8861-50 when ordering.</small>	1 Giga-word (MEMORY BOARD 9715-53 × 1) (analog 12-bit + logic 4-bit) × 1 Giga-word/ch (using 1 channel) to (analog 12-bit + logic 4-bit) × 64 Mega-words/ch (using 16 channels)	2 Giga-words (MEMORY BOARD 9715-53 × 2) (analog 12-bit + logic 4-bit) × 1 Giga-word/ch (using 2 channels) to (analog 12-bit + logic 4-bit) × 64 Mega-words/ch (using 32 channels)
<small>9715-50: 32 Megawords 9715-51: 128 Megawords 9715-52: 512 Megawords 9715-53: 1 Gigaword</small>	<small>Note: 1 word = 2 bytes (12-bits or 16-bits), therefore 1 giga-word = 2 giga-bytes. Note: Internal memory is allocated depending on the number of channels used.</small>	
Data storage media	PC Card Type II slot (standard) × 2: up to 4GB (Flash ATA), FAT, or FAT-32 format supported Hard disk drive (option, HD UNIT 9718-50 *2) × 1: 80GB, FAT-32 format	
<small>*2 Factory installation only</small>		

Basic specifications	8860-50 (max. 4 input modules)	8861-50 (max. 8 input modules)
Backup functions	The following items are preserved on the memory board(s) even after power off: *3 Factory installation only - please specify upon order the MEMORY BACKUP UNIT 9719-50 Clock and parameter setting backup (standard): at least 10 years; at reference temperature (25°C) Waveform backup function (using optional Model 9719-50 *3): 10 hours (8860-50) or 5 hours (8861-50), after full charge, at reference temperature (25°C)	
External control connectors	BNC connectors: external sampling input, sampling sync output Terminal block: external trigger input, trigger output, GO/NG output, external start, external stop, print input	
Calibrator Output	Terminal Block: Select either Trigger Output, or CAL Output to provide a 0/5 V, 1-kHz square wave for adjusting compensation for the intrinsic capacitance of 10:1 and 100:1 probes.	
Standard external interfaces	*4 Using PC Card slot and optional GP-IB card GP-IB *4 : with CONTEC GP-IB CARD GP-IB (CB) FL (for unit control and data transfer), IEEE 488.2-1987 compliant USB: USB2.0 compliant, series A receptacle 3 ports (keyboard, mouse, printer, HDD, USB-memory) LAN: RJ-45 connector, Ethernet 100BASE-TX, 10BASE-T Functions: HTTP server, FTP server, File sharing, DHCP compatible, Send mail Monitor output: 15-pin D-sub connector, SVGA output	
Environmental conditions (no condensation)	Temperature and humidity range for use: 0°C to 40°C, 20% to 80% rh Temperature and humidity range for storage: -10°C to 50°C, 20% to 90% rh	
Compliance standard	Safety: EN61010, EMC: EN61326, EN61000-3-2, EN61000-3-3	
Power requirements	100 to 240 V AC (50/60 Hz) 12 V DC (use the DC POWER UNIT 9684 : option, factory installation only)	
Power consumption	220 VA max. (printer not used) 300 VA max. (A4 printer used)	280 VA max. (printer not used) 350 VA max. (A4 printer used)
Dimensions and mass	Approx. 330 mm (12.99 in) W × 250 mm (9.84 in) H × 184.5 mm (7.26 in) D, 8 kg (282.2 oz) (printer not installed) Approx. 330 mm (12.99 in) W × 272.5 mm (10.73 in) H × 184.5 mm (7.26 in) D, 9.5 kg (335.1 oz) (A4 printer installed) Approx. 330 mm (12.99 in) W × 255.5 mm (10.06 in) H × 184.5 mm (7.26 in) D, 9.0 kg (317.5 oz) (A6 printer installed)	Approx. 330 mm (12.99 in) W × 250 mm (9.84 in) H × 284.5 mm (11.20 in) D, 10.5 kg (370.4 oz) (printer not installed) Approx. 330 mm (12.99 in) W × 272.5 mm (10.73 in) H × 284.5 mm (11.20 in) D, 12 kg (423.3 oz) (A4 printer installed) Approx. 330 mm (12.99 in) W × 255.5 mm (10.06 in) H × 284.5 mm (11.20 in) D, 11.5 kg (405.6 oz) (A6 printer installed)
Supplied accessories	Quick Start Manual × 1, Instruction Manual × 1, Input Module Guide × 1, Analysis Supplement Manual × 1, Power cord × 1, Input cord label × 1, Application Disk (Wave Viewer Wv, Communication Commands table) × 1	

■ Maximum Recording Time for the Memory Function (single timebase)

- One Memory Board Model 9715-50 is installed in the 8860-50, and two in the 8861-50, recording length variable, with 32-MWords.
- Operation cannot be guaranteed when the time axis is longer than one year.
- For memory capacity, 32 MWords is standard as shown in the table below. Optional memory up to 1 GWord can be specified when ordering.

Only First Timebase	No. of used CH	8860-50 : 16ch 8861-50 : 32ch	8860-50 : 8ch 8861-50 : 16ch	8860-50 : 4ch 8861-50 : 8ch	8860-50 : 2ch 8861-50 : 4ch	8860-50 : 1ch 8861-50 : 2ch	
Memory capacity		32MW 128MW 512MW 1GW	20,000 div x4 (80,000 div) x16 (320,000 div) x32 (640,000 div)	40,000 div x4 (160,000 div) x16 (640,000 div) x32 (1,280,000 div)	80,000 div x4 (320,000 div) x16 (1,280,000 div) x32 (2,560,000 div)	160,000 div x4 (640,000 div) x16 (2,560,000 div) x32 (5,120,000 div)	320,000 div x4 (1,280,000 div) x16 (5,120,000 div) x32 (10,240,000 div)

Time axis	Sampling Period	32MW 20,000 div	32MW 40,000 div	32MW 80,000 div	32MW 160,000 div	32MW 320,000 div
5µs/DIV	50ns	100ms	200ms	400ms	800ms	1.6s
10µs/DIV	100ns	200ms	400ms	800ms	1.6s	3.2s
20µs/DIV	200ns	400ms	800ms	1.6s	3.2s	6.4s
50µs/DIV	500ns	1s	2s	4s	8s	16s
100µs/DIV	1µs	2s	4s	8s	16s	32s
200µs/DIV	2µs	4s	8s	16s	32s	1min 04s
500µs/DIV	5µs	10s	20s	40s	1min 20s	2min 40s
1ms/DIV	10µs	20s	40s	1min 20s	2min 40s	5min 20s
2ms/DIV	20µs	40s	1min 20s	2min 40s	5min 20s	10min 40s
5ms/DIV	50µs	1min 40s	3min 20s	6min 40s	13min 20s	26min 40s
10ms/DIV	100µs	3min 20s	6min 40s	13min 20s	26min 40s	53min 20s
20ms/DIV	200µs	6min 40s	13min 20s	26min 40s	53min 20s	1h 46min 40s
50ms/DIV	500µs	16min 40s	33min 20s	1h 06min 40s	2h 13min 20s	4h 26min 40s
100ms/DIV	1ms	33min 20s	1h 06min 40s	2h 13min 20s	4h 26min 40s	8h 53min 20s
200ms/DIV	2ms	1h 06min 40s	2h 13min 20s	4h 26min 40s	8h 53min 20s	17h 46min 40s
500ms/DIV	5ms	2h 46min 40s	5h 33min 20s	11h 06min 40s	22h 13min 20s	4d 20h 26min 40s
1s/DIV	10ms	5h 33min 20s	11h 06min 40s	22h 13min 20s	4d 20h 26min 40s	3d 16h 53min 20s
2s/DIV	20ms	11h 06min 40s	22h 13min 20s	4d 20h 26min 40s	3d 16h 53min 20s	7d 09h 46min 40s
5s/DIV	50ms	1d 03h 46min 40s	2d 07h 33min 20s	4d 15h 06min 40s	9d 06h 13min 20s	18d 12h 26min 40s
10s/DIV	100ms	2d 07h 33min 20s	4d 15h 06min 40s	9d 06h 13min 20s	18d 12h 26min 40s	37d 00h 53min 20s
30s/DIV	300ms	6d 22h 40min 00s	13d 21h 20min 00s	27d 18h 40min 00s	55d 13h 20min 00s	111d 02h 40min 00s
1min/DIV	600ms	13d 21h 20min 00s	27d 18h 40min 00s	55d 13h 20min 00s	111d 02h 40min 00s	222d 05h 20min 00s
100s/DIV	1.0s	23d 03h 33min 20s	46d 07h 06min 40s	92d 14h 13min 20s	185d 04h 26min 40s	370d 08h 53min 20s
2min/DIV	1.2s	27d 18h 40min 00s	55d 13h 20min 00s	111d 02h 40min 00s	222d 05h 20min 00s	- abbreviated -
5min/DIV	3.0s	69d 10h 40min 00s	138d 21h 20min 00s	277d 18h 40min 00s	- abbreviated -	- abbreviated -

■ Maximum Recording Time for the Memory Function (dual timebase)

- One Memory Board Model 9715-50 is installed in the 8860-50, and two in the 8861-50, recording length variable, with 32-MWords.
- Operation cannot be guaranteed when the time axis is longer than one year.
- For memory capacity, 32 MWords is standard as shown in the table below. Optional memory up to 1 GWord can be specified when ordering.

First Timebase	No. of used CH	8860-50 : 16ch 8861-50 : 32ch	8860-50 : 8ch 8861-50 : 16ch	8860-50 : 4ch 8861-50 : 8ch	8860-50 : 2ch 8861-50 : 4ch	8860-50 : 1ch 8861-50 : 2ch	
Second Timebase		8860-50: 8 × 8ch 8861-50: 16 × 8ch	8860-50: 8 × 8ch 8861-50: 16 × 8ch	8860-50: 4 × 8ch 8861-50: 8 × 8ch	8860-50: 2 × 8ch 8861-50: 4 × 8ch	8860-50: 1 × 8ch 8861-50: 2 × 8ch	
Memory capacity		32MW 128MW 512MW 1GW	1,000 div x5 (5,000 div) x20 (20,000 div) x40 (40,000 div)	2,000 div x5 (10,000 div) x20 (40,000 div) x40 (80,000 div)	5,000 div x4 (20,000 div) x16 (80,000 div) x32 (160,000 div)	10,000 div x4 (40,000 div) x16 (160,000 div) x32 (320,000 div)	20,000 div x4 (80,000 div) x16 (320,000 div) x32 (640,000 div)

Time axis	Sampling Period	32MW 1,000 div	32MW 2,000 div	32MW 5,000 div	32MW 10,000 div	32MW 20,000 div
5µs/DIV	50ns	5ms	10ms	25ms	50ms	100ms
10µs/DIV	100ns	10ms	20ms	50ms	100ms	200ms
20µs/DIV	200ns	20ms	40ms	100ms	200ms	400ms
50µs/DIV	500ns	50ms	100ms	250ms	500ms	1s
100µs/DIV	1µs	100ms	200ms	500ms	1s	2s
200µs/DIV	2µs	200ms	400ms	1s	2s	4s
500µs/DIV	5µs	500ms	1s	2.5s	5s	10s
1ms/DIV	10µs	1s	2s	5s	10s	20s
2ms/DIV	20µs	2s	4s	10s	20s	40s
5ms/DIV	50µs	5s	10s	25s	50s	1min 40s
10ms/DIV	100µs	10s	20s	50s	1min 40s	3min 20s
20ms/DIV	200µs	20s	40s	1min 40s	3min 20s	6min 40s
50ms/DIV	500µs	50s	1min 40s	4min 10s	8min 20s	16min 40s
100ms/DIV	1ms	1min 40s	3min 20s	8min 20s	16min 40s	33min 20s
200ms/DIV	2ms	3min 20s	6min 40s	16min 40s	33min 20s	1h 06min 40s
500ms/DIV	5ms	8min 20s	16min 40s	41min 40s	1h 23min 20s	2h 46min 40s
1s/DIV	10ms	16min 40s	33min 20s	1h 23min 20s	2h 46min 40s	5h 33min 20s
2s/DIV	20ms	33min 20s	1h 6min 40s	2h 46min 40s	5h 33min 20s	11h 06min 40s
5s/DIV	50ms	1h 23min 20s	2h 46min 40s	6h 56min 40s	13h 53min 20s	1d 03h 46min 40s
10s/DIV	100ms	2h 46min 40s	5h 33min 00s	13h 53min 20s	1d 03h 46min 40s	2d 07h 33min 20s
30s/DIV	300ms	8h 20min 00s	16h 40min 00s	1d 17h 40min 00s	3d 11h 20min 00s	6d 22h 40min 00s
1min/DIV	600ms	16h 40min 00s	33h 20min 00s	3d 11h 20min 00s	6d 22h 40min 00s	13d 21h 20min 00s
100s/DIV	1.0s	1d 03h 46min 40s	2d 07h 33min 20s	5d 18h 53min 20s	11d 13h 46min 40s	23d 03h 33min 20s
2min/DIV	1.2s	1d 09h 20min 00s	2d 18h 40min 00s	6d 22h 40min 00s	13d 21h 20min 00s	27d 18h 40min 00s
5min/DIV	3.0s	3d 11h 20min 00s	6d 22h 40min 00s	17d 08h 40min 00s	34d 17h 20min 00s	69d 10h 40min 00s

■ Main unit Specifications

Print/display section ^{*6} Printer functions are available when optional printer unit is installed	
Display	10.4 inch TFT color LCD (SVGA, 800 × 600 dots)
^{*6} Recording paper	RECORDING PAPER 9231: 216 mm (8.50 in) × 30 m (98.43 ft), thermal paper roll (when using A4-size the printer unit 8995) RECORDING PAPER 9234: 112 mm (4.41 in) × 18 m (59.06 ft), thermal paper roll (when using A6-size the printer unit 8995-01)
^{*6} Recording width	RECORDING PAPER 9231: 200 mm (7.87 in), full scale 20 divisions, 1 division = 10 mm (0.39 in) (when using A4-size the printer unit 8995) RECORDING PAPER 9234: 100 mm (3.94 in), full scale 10 divisions, 1 division = 10 mm (0.39 in) (when using A6-size the printer unit 8995-01)
^{*6} Paper feed density	10 lines/mm (when using A4-size the printer unit 8995), 8 lines/mm (when using A6-size the printer unit 8995-01) ^{*20 lines/mm with "smoothed printing" memory function (when using A4-size the printer unit 8995)}
^{*6} Recording speed	Max. 25 mm (0.98 in)/sec
Trigger functions	
Trigger sources	Turn on/off independently for each trigger source of analog/logic A – D, external trigger (a rise of 2.5V or terminal short circuit); timer trigger, inter-source AND/OR, forced trigger, standard mode (trigger source to all analog channels settable), extend mode (multiple analog sources to a single analog channel settable, up to 8 for 8860-50 , and up to 8 on channels/units 1 – 4, and up to 8 on channels/units 5 – 8 for 8861-50 settable)
Trigger types (analog)	Level: Triggering occurs when preset voltage level is crossed (upwards or downwards). Window: Triggering occurs when window defined by upper and lower limit is entered or exited. Period: Rising edge or falling edge cycle of preset voltage value is monitored and triggering occurs when defined cycle range is exceeded. Glitch: Triggering occurs when pulse width from rising or falling edge of preset voltage value is underrun. Slope: Triggering occurs when preset change degree (slope) is exceeded or underrun. Voltage drop: Triggering occurs when voltage drops below peak voltage setting (for 50/60 Hz AC power lines only). Event setting: Event count is performed for each source, and triggering occurs when a preset count is exceeded.
Level setting resolution	0.1% of full scale (full scale = 20 divisions)
Trigger types (logic)	1, 0, 0 1, ×, pattern setting, AND/OR setting for groups of 4 channels, level or edge detect selectable (0 1: changing to any value activates trigger)
Trigger filter (analog/logic)	OFF, setting range 0.1 to 10.0 divisions in 0.1 division steps (MEM, REC & MEM function), ON (10 ms)/OFF (REC function)
Other functions	Pre-trigger function to capture pre- and post-trigger waveform, trigger output (active Low with terminal block and open collector 5 voltage output). Level display while waiting for trigger, Start/stop trigger conditions independently selectable
Memory functions	
Time axis	5 μs to 5 min/division, 26 ranges or external sampling, time axis resolution 100 points/division, time axis zoom: ×2 to ×10 in 3 stages, compression: 1/2 to 1/500,000 in 17 stages
Sampling rate	Fixed: 1/100 of time axis range, Variable: external sampling Sampling period can be used to set time axis Two different sampling rate settings are possible
Recording length	32 MW memory: free setting in 1-division steps (max. 320,000 div ^{*7}) or built-in presets of 25 to 200,000 divisions ^{*7} 128 MW memory: free setting in 1-division steps (max. 1,280,000 div ^{*7}) or built-in presets of 25 to 1,000,000 divisions ^{*7} 512 MW memory: free setting in 1-division steps (max. 5,120,000 div ^{*7}) or built-in presets of 25 to 5,000,000 divisions ^{*7} 1 GW memory: free setting in 1-division steps (max. 10,240,000 div ^{*7}) or built-in presets of 25 to 10,000,000 divisions ^{*7} ^{*7} Maximum recording length or built-in preset length when using 1 channel (8860-50) or 2 channels (8861-50). Memory of 8861-50 is twice that of 8860-50 , but recording length is the same.
Pre-trigger	Record data from before the trigger point, -100 to +100% of recording length (free setting in 1% steps)
Screen and printing	Split screen (1 to 16), X-Y screen (1, 4 screens, max. 16 combined), sheet display (max. 32 channels per sheet), logging (print/display measurement data as digital values), voltage axis zoom (×2 to ×100), compression (×1/2 to ×1/10), overlay, zoom, variable display, vernier display
Memory splitting	Divided use of memory space (up to 4096 divisions), sequential save, block search
Waveform calculation	Four arithmetic operations, absolute value, exponentiation, common logarithm, square root, moving average, differentiation once and twice, integration once and twice, parallel displacement along the time axis, trigonometric functions (sin, cos, tan, arc-sin, arc-cos, arc-tan). Any of 16 calculation types can be applied to recording lengths of up to 1/4 of memory capacity
Numerical calculation	(Numerical calculation by specifying calculation area with cursors A and B, numerical calculation judgment, automatic saving of numerical calculation results, saving of any existing numerical calculation results) Average value, effective (rms) value, peak to peak value, maximum value, time to maximum value, minimum value, time to minimum value, period, frequency rise time, fall time, area value, X-Y area value, standard deviation, time to level, pulse width, duty ratio, pulse count, Up to 16 items can be selected.
Averaging	Cumulative average, Exponential average (select 2 to 10,000 data objects to be averaged)

Recorder functions	
Time axis	10 ms to 200 ms ^{*8} /division, 500 ms to 1 hour/div with 19 ranges, time axis resolution 100 points/division, time axis zoom: ×2 to ×4 in 2 stages, compression: 1/2 to 1/20,000 in 13 stages At recording length "continuous", time axis 20 ms/div to 1 hour/div With scanner module 8958 , time axis 50ms/div to 1 hour/div ^{*8} Virtual record function: At 10 ms - 200 ms/division, printing in real time is not possible, but waveform data are stored in memory and can be monitored on screen. Data are stored for 5,000 divisions before the end of measurement. At recording length settings other than "Continuous", the printer can be used simultaneously, for follow-up printing of waveforms.
Sampling rate	100 ns to 1 sec in 8 stages (selectable in 1/100 of time axis range)
Recording length	32 MW memory: free setting in 1-division steps (max. 5,000 div), continuous ^{*9} , up to 1,000 divisions use with the scanner module 8958 128 MW memory: free setting in 1-division steps (max. 20,000 div), continuous ^{*9} , up to 5,000 divisions use with the scanner module 8958 512 MW memory: free setting in 1-division steps (max. 80,000 div), continuous ^{*9} , up to 20,000 divisions use with the scanner module 8958 1 GW memory: free setting in 1-division steps (max. 160,000 div), continuous ^{*9} , up to 40,000 divisions use with the scanner module 8958 ^{*9} At time axis 10 ms to 200 ms/division and printer ON, Continuous setting cannot be selected. At use with the Printer Unit 8995-01 and numerical print ON, time axis 10 ms to 1 sec/division is disabled Note: Memory of the 8861-50 is twice that shown above, but recording length is the same.
Waveform memory	Store data for most recent 5,000 ^{*10} divisions, or up to 160,000 div in memory. Backward scrolling and re-printing available. ^{*10} Depending on the amount of installed memory, Memory of 8861-50 or 8861 is twice that of 8860-50 or 8860 , but recording length is the same.
Screen and printing	Split screen (1 to 8), sheet display (max. 32 channels per sheet), logging (print/display measurement data as digital values), voltage axis zoom (×2 to ×100), compression (×1/2 to ×1/10), variable display

REC & MEM function	
Time axis (REC)	100 ms to 1 hour/division, 16 ranges, time axis resolution 100 points/division, sampling rate: same as sampling rate for MEM function. Recording data of the scanner module 8958 in REC side.
Time axis (MEM)	10 μs to 5 min/division, 25 ranges, time axis resolution 100 points/division, sampling rate: 1/100 of time axis
Recording length	REC: 25 to 2,000 ^{*11} divisions, or up to 80,000 div ^{*11} , continuous MEM: 25 to 5,000 ^{*11} divisions, or up to 160,000 div ^{*11} ^{*11} Depends on installed memory 32 MW to 1GW (free setting in 1-division steps also possible)
Waveform Memory (REC)	The last 2,500 ^{*11} divisions, or up to 80,000 div ^{*11} are saved to memory for scroll-back and re-print. Limited according to whether 16-Ch Scanner Module 8958 is installed.
Screen and printing	Toggle REC/MEM waveform display, simultaneous display of REC/MEM waveform with split screen, split screen (1 to 8), sheet display (max. 32 channels per sheet), logging (print/display measurement data as digital values), zoom (with MEM), variable display
Memory divide	Divided use of memory space (up to 1024 divisions), sequential save, block search

FFT function	
Analysis mode	Storage waveform, linear spectrum, RMS spectrum, power spectrum, power spectrum density, cross power spectrum, power spectrum density (LPC), auto-correlation function, histogram, transfer function, cross-correlation function, phase spectrum, impulse response, coherence function, octave analysis
Analysis channels	1-channel FFT, 2-channel FFT in selected channels (up to 16 analysis functions)
Frequency range	133 mHz to 8 MHz, resolution 1/400, 1/800, 1/2000, 1/4000, 1/8000
No. of sampling points	1000, 2000, 5000, 10000, 20000 points
Analysis data	Selected from: Newly loaded data / MEM function waveform data / MEM waveform of REC & MEM function
Window functions	Rectangular, Hanning, Exponential, Hamming, Blackman, Blackman-Harris, Flat-top
Screen and printing	Split screen (1/2/4), Nyquist, logging (print/display measurement data as digital values), frequency axis zoom and left/right scrolling
Averaging	Time axis / frequency axis simple averaging, exponential averaging, peak hold, (free setting 2 times to 10,000 times)

Real-time save function	
Time axis (Whole waveform data)	10 ms to 1 hour/division, 19 ranges, time axis resolution 100 points/div, sampling speed: same as sampling rate for "Measurement Waveform"
Time axis (Measurement waveform data: sampling data)	100 μs to 5 min/division, 22 ranges (limited depending on store target and number of channels), time axis resolution 100 points/div, sampling rate: 1/100 of time axis
Save to	HDD, PC via LAN, PC Card (use only HIOKI's card)
Recording length	Depending on available space on storage media / file system / number of channels / REC time axis, Selectable in division steps up to maximum recording length
Screen and printing	During measurement: Whole wave, after measurement: toggle Whole/Measurement waveform display, simultaneous display of Whole/Measurement waveform with split screen, split screen (1 to 8), 16 split (A4-size printer only), sheet display (max. 32 channels per sheet), logging (print/display measurement data as digital values), zoom, variable display
Memory transfer	Data can be analyzed in MEM function or FFT function
Waveform search function	Detection of trigger criteria, time, event markers and peak value Up to 1,000 event markers can be input during and after measurement

Main unit Specifications

Additional features	
General	Measurement parameter printing, cursor measurement, scaling, current clamp setting, comment input, screen hard copy, list/gauge, start condition hold, auto setup, auto save, remote control (start/stop/print control), auto range, over-range indication, VIEW function, key lock, level monitor, vernier function, offset cancel, event marker input, waveform search function, report printing

Options specifications (sold separately) For the 8860 series only

Dimensions and mass: approx. 170 (6.69in) W × 20 (0.79in) H × 148.5 (5.85in) D mm, approx. 290 g (10.2 oz) **Accessories:** None



ANALOG UNIT 8956 (Accuracy at 23 ±5°C/73 ±9°F, 30 to 80% rh after 30 minutes of warm-up time and zero-adjust; accuracy guaranteed for 1 year)	
Measurement functions	Number of channels: 2, for voltage measurement
Input connectors	Isolated BNC connector (input impedance 1MΩ, input capacitance 40pF), Max. rated voltage to earth: 300V AC, DC (with input isolated from the unit, the maximum voltage that can be applied between input channel and chassis and between input channels without damage)
Measurement range	5mV to 20V/DIV, 12 ranges, full scale: 20 DIV, AC voltage for possible measurement/display using the memory function: 280V rms, low-pass filter: 5Hz/500Hz/5kHz/1MHz
Measurement resolution	1/100 of measurement range (using 12-bit A/D conversion; installed in 8860 series)
Highest sampling rate	20MS/s (simultaneous sampling in 2 channels)
Accuracy	DC amplitude: ±0.4% of full scale (with filter 5Hz) Zero position: ±0.1% of full scale (with filter 5Hz, after zero adjustment)
Frequency characteristics	DC to 10MHz ±3dB, (with AC coupling: 7Hz to 10MHz ±3dB)
Input coupling	DC, GND, AC
Max. allowable input	400V DC (the maximum voltage that can be applied across input pins without damage)

Dimensions and mass: approx. 170 (6.69in) W × 20 (0.79in) H × 148.5 (5.85in) D mm, approx. 310 g (10.9 oz) **Accessories:** None



HIGH-RESOLUTION UNIT 8957 (Accuracy at 23 ±5°C/73 ±9°F, 30 to 80% rh after 30 minutes of warm-up time and zero-adjust; accuracy guaranteed for 1 year)	
Measurement functions	Number of channels: 2, for voltage measurement
Input connectors	Isolated BNC connector (input impedance 1MΩ, input capacitance 40pF), Max. rated voltage to earth: 300V AC, DC (with input isolated from the unit, the maximum voltage that can be applied between input channel and chassis and between input channels without damage)
Measurement range	5mV to 20V/DIV, 12 ranges, full scale: 20DIV, AC voltage for possible measurement/display using the memory function: 280V rms, low-pass filter: 5Hz/50Hz/500Hz/5kHz/50kHz
Anti-aliasing filter	Integrated filter for suppressing aliasing distortion caused by FFT processing (automatic cutoff frequency setting/OFF)
Measurement resolution	1/1600 of measurement range (using 16-bit A/D conversion; installed in 8860 series)
Highest sampling rate	2MS/s (simultaneous sampling in 2 channels)
Accuracy	DC amplitude: ±0.2% of full scale (with filter 5Hz) Zero position: ±0.1% of full scale (with filter 5Hz, after zero adjustment)
Frequency characteristics	DC to 200kHz ±3dB, (with AC coupling: 7Hz to 200kHz ±3dB)
Input coupling	DC, GND, AC
Max. allowable input	400V DC (the maximum voltage that can be applied across input pins without damage)

Dimensions and mass: approx. 170 (6.69in) W × 20 (0.79in) H × 183 (7.20in) D mm, approx. 385 g (13.6 oz) **Accessories:** Flathead screwdriver × 1, short bar × 2



16ch SCANNER UNIT 8958 (Accuracy at 23 ±5°C/73 ±9°F, 30 to 80% rh after 1 hour of warm-up time and adjustment; accuracy guaranteed for 1 year)	
Measurement functions	Number of channels: 16, for voltage measurement/temperature measurement with thermocouple
Input connectors	Voltage input/Thermocouple input: screw-type terminal strip, recommended wire diameter ^{#1} , detachable terminal block (with cover) ^{*1} Recommended cable, single-wire: 0.14 to 1.5 mm ² , braided wire 0.14 to 1.0 mm ² (conductor wire diameter min. 0.18 mm), AWG 26 to 16 Input impedance: 1MΩ, 850kΩ with line fault detection ON, Max. rated voltage to earth: 33Vrms or 70V DC (with input isolated from the unit, the maximum voltage that can be applied between input channel and chassis and between input channels without damage)
Voltage measurement range	5m, 50m, 500m, 2V/DIV, 4 ranges, full scale: 20DIV, measurement range: ±100% of full scale, digital filter: 10Hz/50Hz/60Hz, measurement resolution 1/1600 of measurement range (using 16-bit A/D conversion; installed in 8860 series)
Temperature measurement range (Upper and lower limit values depend on measurement input range of sensor)	10°C/DIV (-100°C to +200°C), 50°C/DIV (-200°C to +1000°C), 100°C/DIV (-200°C to +2000°C), 3 ranges, full scale: 20DIV, digital filter: 10Hz/50Hz/60Hz, measurement resolution 1/1000 of measurement range (using 16-bit A/D conversion; installed in 8860 series)
Thermocouple range (JIS C 1602-1995) (ASTM E-988-96)	K: -200 to 1350°C, J: -200 to 1200°C, E: -200 to 1000°C, T: -200 to 400°C, N: -200 to 1300°C, R: 0 to 1700°C, S: 0 to 1700°C, B: 400 to 1800°C, W (WRε5-26): 0 to 2000°C, reference junction compensation: internal/ external (switchable), line fault detection ON/OFF switchable
Data refresh rate	50ms/all channels (digital filter OFF), 300ms/all channels (digital filter 50Hz/60Hz), 1.4 s/all channels (digital filter 10Hz)
Accuracy	Voltage: ±0.2% of full scale, thermocouple (K, J, E, T, N): ±0.05% of full scale ±1°C, (R, S, B, W): ±0.05% of full scale ±2°C (400°C or more), ±0.05% of full scale ±3.5°C (less than 400°C), reference junction compensation accuracy: ±1°C (added to measurement accuracy with internal reference junction compensation)
Max. allowable input	40V DC (the maximum voltage that can be applied across input pins without damage)

Dimensions and mass: approx. 170 (6.69in) W × 20 (0.79in) H × 148.5 (5.85in) D mm, approx. 290 g (10.2 oz) **Accessories:** None



DC/RMS UNIT 8959 (Accuracy at 23 ±5°C/73 ±9°F, 30 to 80% rh after 30 minutes of warm-up time and zero-adjust; accuracy guaranteed for 1 year)	
Measurement functions	Number of channels: 2, for voltage measurement, DC/RMS selectable
Input connectors	Isolated BNC connector (input impedance 1MΩ, input capacitance 30pF), Max. rated voltage to earth: 370V AC, DC (with input isolated from the unit, the maximum voltage that can be applied between input channel and chassis and between input channels without damage)
Measurement range	5mV to 20V/DIV, 12 ranges, full scale: 20DIV, AC voltage for possible measurement/display using the memory function: 280V rms, low-pass filter: 5Hz/500Hz/5kHz/100kHz
Measurement resolution	1/80 of measurement range (using 12-bit A/D conversion; installed in 8860 series)
Highest sampling rate	1MS/s (simultaneous sampling in 2 channels)
Accuracy	DC amplitude: ±0.4% of full scale (with filter 5Hz), zero position: ±0.1% of full scale (with filter 5Hz, after zero adjustment)
RMS measurement	RMS amplitude accuracy: ±1% of full scale (DC, 20Hz to 1kHz), ±3% of full scale (1kHz to 100kHz), response time: SLOW 5s (rise time from 0 to 90% of full scale), MID 800ms (rise time from 0 to 90% of full scale), FAST 100ms (rise time from 0 to 90% of full scale), crest factor: 2
Frequency characteristics	DC to 400kHz ±3dB, (with AC coupling: 7Hz to 400kHz ±3dB)
Input coupling	DC, GND, AC
Max. allowable input	400V DC (the maximum voltage that can be applied across input pins without damage)

Dimensions and mass: approx. 170 (6.69in) W × 20 (0.79in) H × 148.5 (5.85in) D mm, approx. 290 g (10.2 oz) **Accessories:** Conversion cable × 2, cable length 50cm (19.69in)



STRAIN UNIT 8960 (Accuracy at 23 ±5°C/73 ±9°F, 35 to 80% rh after 1 hour of warm-up time and auto-balance; accuracy guaranteed for 1 year)	
Measurement functions	Number of channels: 2, for distortion measurement (electronic auto-balancing, balance adjustment range within ±1000 μe)
Input connectors	Via conversion cable, TAJIMI PRC03-12A10-7M10.5, Max. rated voltage to earth: 33Vrms or 70V DC (with input isolated from the unit, the maximum voltage that can be applied between input channel and chassis and between input channels without damage)
Suitable transducer	Strain gauge converter, bridge impedance: 120Ω to 1kΩ (bridge voltage 2V), 350Ω to 1kΩ (bridge voltage 5V, 10V), bridge voltage 2, 5, 10 ±0.05V
Measurement range	20μe to 1000μe/DIV, 6 ranges, full scale: 20DIV, low-pass filter: 5Hz/10Hz/100Hz/1kHz
Anti-aliasing filter	Integrated filter for suppressing aliasing distortion caused by FFT processing (automatic cutoff frequency setting/OFF)
Measurement resolution	1/1600 of measurement range (using 16-bit A/D conversion; installed in 8860 series)
Highest sampling rate	200k/s (2-channel simultaneous sampling)
Accuracy After auto-balancing	DC amplitude: ±(0.4% of full scale +2μe), zero position: ±(0.1% of full scale +2μe) (at 5Hz filter ON)
Frequency characteristics	DC to 20kHz +1/-3dB
Max. allowable input	10V DC (the maximum voltage that can be applied across input pins without damage)

* Available from main unit 8860/8861 version 1.06

Dimensions and mass: approx. 170 (6.69in) W × 19.8 (0.78in) H × 148.5 (5.85in) D mm, approx. 310 g (10.9 oz) **Accessories:** CONNECTION CORD 9242 × 2, GRABBER CLIP 9243 × 2



HIGH VOLTAGE UNIT 8961 (Accuracy at 23 ±5°C/73 ±9°F, 30 to 80% rh after 30 minutes of warm-up time and zero-adjust; accuracy guaranteed for 1 year)	
Measurement functions	Number of channels: 2, for voltage measurement, DC/RMS selectable
Input connectors	Safety Banana Connector (input impedance 10MΩ, input capacitance 5pF), Max. rated voltage to earth: 1000V AC, DC CAT II, 600V AC, DC CAT III (the maximum voltage that can be applied between input channel and chassis and between input channels without damage)
Measurement range	1V to 50V/DIV, 6 ranges, full scale: 20 DIV, AC voltage for possible measurement/display using the memory function: 700V rms, low-pass filter: 5Hz/50Hz/500Hz/5kHz
Measurement resolution	1/1600 of measurement range (using 16-bit A/D conversion; installed in 8860 series)
Highest sampling rate	2MS/s (simultaneous sampling in 2 channels)
Accuracy	DC amplitude: ±0.25% of full scale (with filter 5Hz) Zero position: ±0.15% of full scale (with filter 5Hz, after zero adjustment)
RMS measurement	RMS amplitude accuracy: ±1% of full scale (DC, 40Hz to 1kHz sin waveform), ±3% of full scale (1kHz to 10kHz sin waveform), crest factor: 2
Frequency characteristics	DC to 100kHz ±3dB
Input coupling	DC, GND
Max. allowable input	1000V DC (the maximum voltage that can be applied across input pins without damage)
Number of modules	Up to four units settable for the 8860-50, or the 8861-50 one main unit.

Options specifications (sold separately) options common to Models 8861-50/8860-50/8861/8860/8842/8841/8835-01/8835/8826/8720

Dimensions and mass: approx. 170 (6.69in) W x 20 (0.79in) H x 148.5 (5.85in) D mm, approx. 290 g (10.2 oz) **Accessories:** None



ANALOG UNIT 8936 (Accuracy at 23 ±5°C/73 ±9°F, 35 to 80 % rh after 30 minutes of warm-up time and zero-adjust; accuracy guaranteed for 1 year)	
Measurement functions	Number of channels: 2, for voltage measurement
Input connectors	Isolated BNC connector (input impedance 1MΩ, input capacitance 30pF), Max. rated voltage to earth: 370V AC, DC (with input isolated from the unit, the maximum voltage that can be applied between input channel and chassis and between input channels without damage)
Measurement range	5mV to 20V/DIV, 12 ranges, full scale: 20DIV, AC voltage for possible measurement/display using the memory function: 280V rms, low-pass filter: 5Hz/500Hz/5kHz/100kHz
Measurement resolution	1/80 of measurement range (using 12-bit A/D conversion; installed in 8860 series)
Highest sampling rate	1MS/s (simultaneous sampling in 2 channels)
Accuracy	DC amplitude: ±0.4% of full scale, zero position: ±0.1% of full scale (after zero adjustment)
Frequency characteristics	DC to 400kHz ±3dB, (with AC coupling: 7Hz to 400kHz ±3dB)
Input coupling	DC, GND, AC
Max. allowable input	400V DC (the maximum voltage that can be applied across input pins without damage)

Note: When using Model 8936 with serial number earlier than 041018234 on Models 8861-50/8860-50/8861/8860, residual noise will be 850 μVp-p.

FFT ANALOG UNIT 8938 (Accuracy at 23 ±5°C/73 ±9°F, 35 to 80 % rh after 30 minutes of warm-up time and zero-adjust; accuracy guaranteed for 1 year)	
Measurement functions	Number of channels: 2, for voltage measurement
Anti-aliasing filter	Integrated filter for suppressing aliasing distortion caused by FFT processing (automatic cutoff frequency setting/OFF)
Other functions	Other specifications same as the ANALOG UNIT 8936

Note: When using Model 8938 with serial number earlier than 041132532 on Models 8861-50/8860-50/8861/8860, residual noise will be 1.4 mVp-p.

Dimensions and mass: approx. 170 (6.69in) W x 20 (0.79in) H x 148.5 (5.85in) D mm, approx. 300 g (10.6 oz) **Accessories:** None



VOLTAGE/TEMP UNIT 8937 (Accuracy at 23 ±5°C/73 ±9°F, 35 to 80 % rh after 1 hour of warm-up time and zero-adjust; accuracy guaranteed for 1 year)	
Measurement functions	Number of channels: 2, for voltage measurement/temperature measurement with thermocouple
Input connectors	Voltage input: metallic BNC connector (input impedance 1MΩ, input capacitance 50pF), thermocouple input: plug-in connector (input impedance min. 5.1MΩ), Max. rated voltage to earth: 30Vrms or 60V DC (with input isolated from the unit, the maximum voltage that can be applied between input channel and chassis and between input channels without damage)
Voltage measurement range	500μV to 2 V/DIV, 12 ranges, full scale: 20DIV, low-pass filter: 5Hz/500Hz/5kHz/100kHz, Measurement resolution: 1/80 of measurement range (using 12-bit A/D conversion; installed in 8860 series)
Temperature measurement range	10°C to 100°C/DIV, 4 ranges, full scale: 20DIV, low-pass filter: 5Hz/500Hz, Measurement resolution: 1/80 of measurement range (using 12-bit A/D conversion; installed in 8860 series)
Thermocouple range	K: -200 to 1350°C, E: -200 to 800°C, J: -200 to 1100°C, T: -200 to 400°C, N: -200 to 1300°C, R: 0 to 1700°C, S: 0 to 1700°C, B: 300 to 1800°C, Reference junction compensation: internal/external (switchable)
Highest sampling rate	Voltage input: 1MS/s, Temperature measurement: 4kS/s (2-channel simultaneous sampling)
Accuracy	Voltage input: DC amplitude ±0.4% of full scale, zero position ±0.15% of full scale, Temperature measurement (K, E, J, T, N): ±0.1% of full scale ±1°C, ±0.1% of full scale ±2°C (-200 to 0°C), (R, S): ±0.1% of full scale ±3°C, (B): ±0.1% of full scale ±4°C (400 to 1800°C), Reference junction compensation accuracy: ±0.1% of full scale ±1.5 °C (internal reference junction compensation)
Frequency characteristics	Voltage input: DC to 400 kHz +1/-3dB Temperature measurement: DC to 1kHz +1/-3dB
Input coupling	DC, GND, AC
Max. allowable input	30Vrms or 60V DC (the maximum voltage that can be applied across input pins without damage)

Note: When using Model 8937 with serial number earlier than 041135257 on Models 8861-50/8860-50/8861/8860, residual noise will be 150 μVp-p.

Dimensions and mass: approx. 170 (6.69in) W x 20 (0.79in) H x 148.5 (5.85in) D mm, approx. 250 g (8.8 oz) **Accessories:** Conversion cable x 2



STRAIN UNIT 8939 (Accuracy at 23 ±5°C/73 ±9°F, 35 to 80 % rh after 1 hour of warm-up time and auto-balance; accuracy guaranteed for 1 year)	
Measurement functions	Number of channels: 2, for distortion measurement (electronic auto-balancing, balance adjustment range within ±10000μe)
Input connectors	Via conversion cable, TAJIMI PRC03-12A10-7M10.5, Max. rated voltage to earth: 30Vrms or 60V DC (with input isolated from the unit, the maximum voltage that can be applied between input channel and chassis and between input channels without damage)
Suitable transducer	Strain gauge converter, bridge impedance: 120Ω to 1kΩ, bridge voltage 2 ±0.05V
Measurement range	20μe to 1000μe/DIV, 6 ranges, full scale: 20DIV, low-pass filter: 10Hz/30Hz/300Hz/3kHz
Measurement resolution	1/80 of measurement range (using 12-bit A/D conversion; installed in 8860 series)
Highest sampling rate	1MS/s (2-channel simultaneous sampling)
Accuracy After auto-balancing	DC amplitude: ±(0.5% of full scale +2μe), zero position: ±0.5% of full scale
Frequency characteristics	DC to 20 kHz +1/-3dB
Max. allowable input	10V DC + AC peak (the maximum voltage that can be applied across input pins without damage)

CONVERSION CABLE 9318 (to connect 9270 to 9272, 9277 to 9279 and 8940)
CONVERSION CABLE 9319 (to connect 3273, 3273-50 and 8940)

Dimensions and mass: approx. 170 (6.69in) W x 20 (0.79in) H x 148.5 (5.85in) D mm, approx. 300 g (10.6 oz) **Accessories:** None

F/V UNIT 8940 (Accuracy at 23 ±5°C/73 ±9°F, 35 to 80 % rh after 30 minutes of warm-up time and zero-adjust; accuracy guaranteed for 1 year)	
Measurement functions	Number of channels: 2, for voltage input based frequency measurement, integration, pulse duty ratio, current (with optional clamp-on sensor), and voltage measurement
Input connectors	Metallic BNC connector (input impedance 1MΩ, input capacitance 60pF), sensor connector (dedicated connector for clamp-on sensor via conversion cable, common ground with recorder), Max. rated voltage to earth: 30Vrms or 60V DC (with input isolated from the unit, the maximum voltage that can be applied between input channel and chassis and between input channels without damage)
Compatible current sensors	9270, 9271, 9272, 9277, 9278, 9279, 3273, 3273-50
Measurement range	Frequency: DC to 100kHz, with 0.05Hz to 5kHz/DIV, 11 ranges, 5 (τ/min) to 500 (τ/min)/DIV, 5 ranges, P50Hz (40 to 60Hz), P60Hz (50 to 70Hz) * Power line frequency measurement requires the DIFFERENTIAL PROBE 9322 or PT 9303, Accuracy: ±0.2% of full scale (except 5kHz/DIV range), ±0.7% of full scale (5kHz/DIV range), ±0.032Hz (P50Hz, P60Hz range) Integration: DC to 90kHz, with 5counts to 500kcounts/DIV, 11 ranges Pulse duty ratio: 10Hz to 100kHz, with 100% of full scale, 1 range, Accuracy: ±1% of full scale (10Hz to 10kHz) Threshold: -10 to +10V (settable in 0.2V steps) Full scale: 20DIV, Max. allowable input: 30Vrms or 60V DC (the maximum voltage that can be applied across input pins without damage)
Measurement range	Voltage: 0.5mV to 2V/DIV, 12 ranges Current: 5mA to 100A/DIV, 10 ranges, using current sensor (powered from the 8940, max. 4 sensors total) DC amplitude accuracy: ±0.4% of full scale, zero position ±0.15% of full scale (current measurement accuracy dependent on sensor accuracy/characteristics) Frequency characteristics: DC to 400kHz ±3dB Full scale: 20DIV, Max. allowable input: 30Vrms or 60V DC (the maximum voltage that can be applied across input pins without damage)
Measurement resolution	1/80 of measurement range (installed in 8860 series, excluding current range when using 9279)
Highest sampling rate	1MS/s (2-channel simultaneous sampling), (frequency/duty ratio measurement: 1.125μs cycle)
Other functions	Voltage input pull-up: ON (10kΩ)/OFF, input coupling: DC, GND, AC (voltage/current), DC (others), low-pass filter: 5Hz/500Hz/5kHz/100kHz

Dimensions and mass: approx. 170 (6.69in) W x 20 (0.79in) H x 148.5 (5.85in) D mm, approx. 310 g (10.9 oz) **Accessories:** None



4ch ANALOG UNIT 8946 (Accuracy at 23 ±5°C/73 ±9°F, 35 to 80 % rh after 30 minutes of warm-up time and zero-adjust; accuracy guaranteed for 1 year)	
Measurement functions	Number of channels: 4, for voltage measurement
Input connectors	Metallic BNC connector (input impedance 1MΩ, input capacitance 15pF), Max. rated voltage to earth: 30Vrms or 60V DC (with input isolated from the unit, the maximum voltage that can be applied between input channel and chassis and between input channels without damage)
Measurement range	10mV to 2V/DIV, 8 ranges, full scale: 20DIV, low-pass filter, 5Hz/500Hz/5kHz/50kHz, input coupling: DC, GND
Measurement resolution	1/80 of measurement range (using 12-bit A/D conversion; installed in 8860 series)
Highest sampling rate	1MS/s (4-channel simultaneous sampling)
Accuracy	DC amplitude: ±0.5% of full scale, zero position: ±0.15% of full scale (after zero adjustment)
Frequency characteristics	DC to 100kHz ±3dB
Max. allowable input	30Vrms or 60V DC (the maximum voltage that can be applied across input pins without damage)

Dimensions and mass: approx. 170 (6.69in) W x 20 (0.79in) H x 148.5 (5.85in) D mm, approx. 310 g (10.9 oz) **Accessories:** None



CHARGE UNIT 8947 (Accuracy at 23 ±5°C/73 ±9°F, 35 to 80 % rh after 1 hour of warm-up time and zero-adjust; accuracy guaranteed for 1 year)	
Measurement functions	Number of channels: 2, for acceleration measurement
Input connectors	Voltage input/integrated preamplifier input: metallic BNC connector (for voltage input: input impedance 1MΩ, input capacitance 200pF or less) Charge input: miniature connector (#10-32 UNF) Max. rated voltage to earth: 30Vrms or 60V DC (with input isolated from the unit, the maximum voltage that can be applied between input channel and chassis and between input channels without damage)
Suitable transducer	Charge input: Charge-output type piezoelectric acceleration pick-up sensor Internal preamp input: Acceleration pick-up sensor with an internal preamp
Measurement range	50m (m/s ²)/DIV to 10k (m/s ²)/DIV, 12 ranges x 6 types, charge input sensitivity: 0.1 to 10 pC/(m/s ²), integrated pre-amplifier input: 0.1 to 10 mV/(m/s ²), amplitude accuracy: ±2% of full scale, frequency characteristics: 1 to 50kHz, +1/-3dB, low-pass filter: 500Hz/5kHz, pre-amplifier drive power source: 2mA ±20%, +15V ±5%, maximum input charge: ±500pC (high-sensitivity setting, 6 ranges), ±50000pC (low-sensitivity setting, 6 ranges)
Measurement range	500μV to 2V/DIV, 12 ranges, DC amplitude accuracy: ±0.4% of full scale, frequency characteristics: DC to 400kHz, +1/-3 dB, low-pass filter: 5Hz/500Hz/5kHz/100kHz, input coupling: DC, GND, AC, Max. allowable input: 30Vrms or 60V DC
Measurement resolution	1/80 to 1/32 of measurement range (depending on measurement sensitivity; installed in 8860 series)
Highest sampling rate	1MS/s (2-channel simultaneous sampling)
Anti-aliasing filter	Integrated filter for suppressing aliasing distortion caused by FFT processing (automatic cutoff frequency setting/OFF)

Note: When using Model 8947 with serial number earlier than 040933650 on Models 8861-50/8860-50/8861/8860, residual noise will be 200 μVp-p.

■ Options specifications (sold separately)

Cable length and mass: Main unit cable 1.5 m (4.92 ft), input section cable 30 cm (0.98 ft), approx. 150 g (5.3 oz)
 Note: The unit-side plug of the **9320-01** is different from the **9320**.



LOGIC PROBE 9320-01/9327 (Accuracy at 23 ±5°C/73 ±9°F, 35 to 80% rh, accuracy / product guaranteed for 1 year)	
Function	Detection of voltage signal or relay contact signal for High/Low state recording
Input	4 channels (common ground between unit and channels), digital/contact input, switchable (contact input can detect open-collector signals) Input resistance: 1 MΩ (with digital input, 0 to +5 V) 500 kΩ or more (with digital input, +5 to +50V) Pull-up resistance: 2 kΩ (contact input: internally pulled up to +5 V)
Digital input threshold	1.4V / 2.5V / 4.0V
Contact input detection resistance	1.4 V: 1.5 kΩ or higher (open) and 500 Ω or lower (short) 2.5 V: 3.5 kΩ or higher (open) and 1.5 kΩ or lower (short) 4.0 V: 25 kΩ or higher (open) and 8 kΩ or lower (short)
Response speed	9320-01: 500ns or lower, 9327: detectable pulse width 100ns or higher
Max. allowable input	0 to +50V DC (the maximum voltage that can be applied across input pins without damage)

Cable length and mass: Main unit cable 1.5 m (4.92 ft), input section cable 1 m (3.28 ft), approx. 320 g (11.3 oz)
 Note: The unit-side plug of the **MR9321-01** is different from the **MR9321**.



LOGIC PROBE MR9321-01 (Accuracy at 23 ±5°C/73 ±9°F, 35 to 80% rh, accuracy / product guaranteed for 1 year)	
Function	Detection of AC or DC relay drive signal for High/Low state recording Can also be used for power line interruption detection
Input	4 channels (isolated between unit and channels), HIGH/LOW range switching Input resistance: 100 kΩ or higher (HIGH range), 30 kΩ or higher (LOW range)
Output (H) detection	170 to 250 V AC, ±DC 70 to 250 V (HIGH range) 60 to 150 V AC, ±DC 20 to 150 V (LOW range)
Output (L) detection	0 to 30 V AC, ±DC 0 to 43 V (HIGH range) 0 to 10 V AC, ±DC 0 to 15 V (LOW range)
Response time	Rising edge 1 ms max., falling edge 3 ms max. (with HIGH range at 200 V DC, LOW range at 100 V DC)
Max. allowable input	250 Vrms (HIGH range), 150 Vrms (LOW range) (the maximum voltage that can be applied across input pins without damage)

Cable length and mass: Main unit cable 1.3 m (4.27 ft), input section cable 46 cm (1.51 ft), approx. 350 g (12.3 oz)



DIFFERENTIAL PROBE 9322 (Accuracy at 23 ±5 °C/73 ±9 °F, 35 to 80 % rh after 30 minutes of warm-up time, accuracy / product guaranteed for 1 year)	
Functions	For high-voltage floating measurement, power line surge noise detection, RMS rectified output measurement
DC mode	For waveform monitor output, Frequency characteristics: DC to 10 MHz (±3 dB), Amplitude accuracy: ±1 % of full scale (at max. 1000 V DC), ±3% of full scale (at max. 2000 V DC) (full scale: 2000 V DC)
AC mode	For detection of power line surge noise, Frequency characteristics: 1 kHz to 10 MHz ±3 dB
RMS mode	DC/AC voltage RMS output detection, Frequency characteristics: DC, 40 Hz to 100 kHz, Response speed: 200 ms or less (400 V AC), accuracy: ±1 % of full scale (DC, 40 Hz to 1 kHz), ±4 % of full scale (1 kHz to 100 kHz) (full scale: 1000 V AC)
Input	Input type: balanced differential input, Input impedance/capacitance: H-L 9 MΩ/10 pF, H/L-unit 4.5 MΩ/20 pF, Max. rated voltage to earth: when using grabber clip 1500V AC/DC (CAT II), 600 V AC/DC (CAT III), when using alligator clip: 1000 V AC/DC (CAT II), 600 V AC/DC (CAT III)
Max. allowable input	2000 V DC, 1000 V AC (CAT II), 600 V AC/DC (CAT III)
Output	Voltage divider for 1/1000 of input, BNC connectors (output switchable for 3 modes DC, AC, RMS)
Power source	(1) Connect the AC ADAPTER 9418-15, (2) Connect to the PROBE POWER UNIT 9687 via the POWER CORD 9248, (3) Connect to HiCORDER logic terminal via the POWER CORD 9324 and CONVERSION CABLE 9323, (4) Connect to the F/V UNIT 8940 via the POWER CORD 9325.

Dimensions and mass: approx. 315.8 (12.43in) W × 29 (1.14in) H × 244.4 (9.62in) D mm, approx. 1.25 kg (44.1oz) Accessories: None



DC POWER UNIT 9684 Note: Factory-installed option, built in on the bottom case of the main unit	
Rated input voltage	12V DC (input range : 10 to 16V DC)
Power requirements	200VA (printer used)

Note: Only one of either the DC Power Unit 9684 or Probe Power Unit 9687 can be installed at any one time. Please contact your HIOKI representative if concurrent installation is required.

Dimensions and mass: approx. 315.8 (12.43in) W × 18.2 (0.72in) H × 244.4 (9.62in) D mm, approx. 570 g (20.1oz) Accessories: None



PROBE POWER UNIT 9687 Note: Factory-installed option, built in on the bottom case of the main unit	
No. of powered channels	8 Channels, Output current: Up to 3 A total (Total combined current consumption of connected probes should be no more than 3 A)
Compatible current probes	3273 (0.25 A max. current consumption): exclusive, up to 8 probes 3273-50 (0.47 A max. current consumption): exclusive, up to 6 probes 3274 (0.46 A max. current consumption): exclusive, up to 6 probes 3275 (0.60 A max. current consumption): exclusive, up to 5 probes 3276 (0.44 A max. current consumption): exclusive, up to 6 probes
Compatible voltage probes	9322 (0.15 A max. current consumption): exclusive, up to 8 probes

Note: Only one of either the DC Power Unit 9684 or Probe Power Unit 9687 can be installed at any one time. Please contact your HIOKI representative if concurrent installation is required.

Perform the same functions on the computer

■ MEMORY HiVIEWER 9725

- 1) Application software enables you to perform the same data analysis on a Windows computer as on the MEMORY HiCORDERs 8860 series.
- 2) No confusion, because the screens appearing on the computer are identical to those of the 8860 series.
- 3) Functions identical to those of the 8860 series, such as waveform processing calculation, run on the computer.

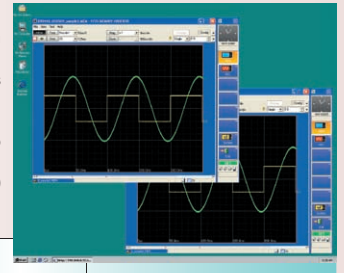

MEMORY HiVIEWER 9725

Compatible devices	MEMORY HiCORDER 8860-50, 8861-50, 8860, 8861
Supplied Media	One CD-R disc
Operating environment	Computer running under Windows 2000, XP (32bit), Vista (32-bit), or Windows 7 (32-bit/64-bit)
File loading	Readable data formats : Only for 8860 series data (MEM, REC, FFT, SEQ, IDX, SET) Maximum file size : 2 GW
File saving	Saved contents: measurement data (binary and ASCII), (partial saving of the area between cursors A and B), setting conditions, screen image (BMP, PNG), and calculation results
Display	Waveform display: 1-, 2-, 3-, 4-, 6-, and 8-split screen, horizontal, vertical, consecutive scroll, and zoom in/out along the time axis, move the zero position, zoom in/out, setting of variables independently for each channel X-Y-axis composite display (for the MEM function only): 1-, 2-, and 4-split display, dot/line interpolation, composite area can be specified Numerical display: digital values of waveform data can be displayed Display sheet: 16 sheets Display channel count (per sheet): 32 analog channels, 16 logic channels, 16 calculated waveforms, 8 X-Y-axis composite waveforms Cursor function: vertical cursor, horizontal cursor, trace cursor, two cursors (cursor A and cursor B), time and voltage display Clipboard copy: images on the waveform screen can be transferred to the clipboard
Print	Supported printer: printer compatible with the OS Print format: waveform image (1-, 2-, 3-, 4-, 6-, 8-, and 16-split), numerical print, report format, list print, calculation results, screen image Print area: the entire area, area between cursors A and B Print preview: supported

Data Analysis and Presentation Software

■ Features

FlexPro is a powerful data analysis and presentation software for importing and organizing data from the 8860-50/8861-50 Series.

Note: Product Company: Weisang GmbH (Germany)
 Contact: Email: info@weisang.com
 http://www.weisang.com/

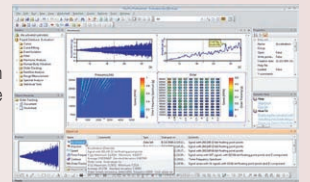

FlexPro (data analysis and presentation software)

Overview	<ul style="list-style-type: none"> • Gather large data sets from multiple channels measured in different timebases • Analyze and view results using the easy-to-navigate tabbed window interface • Powerful search function lets you shift through large sets of accumulated data of virtually any size
Functions	Over 100 analysis functions in both the time-domain and frequency-domain, including: <ul style="list-style-type: none"> • Fourier Spectral Analysis • Time Frequency Spectral Analysis • Harmonic Analysis • Shock Response Analyses Active Folder model for setting up a template of both diagrams and functions that update every time a new signal is captured
Data Presentation	<ul style="list-style-type: none"> • Images in all common formats can be imported or exported • Export analyzed data either in traditional .CSV, .RTF or .TXT formats or to 3rd party software to accommodate existing database structures • Easily arrange objects such as 2-D and 3-D diagrams, result tables and company logos in a report or on website • Prepared report templates are automatically updated when new measurements are made • Make cursor measurements, scrolling and zooming directly from the report

■ PC Software Specifications Bundled with the 8860-50/8861-50s in the CD-R
 Note: With use of the 8860-50/8861-50, Wv ver 1.25 or later

Wave Viewer (Wv) Software

Functions	<ul style="list-style-type: none"> • Simple display of waveform file • Text conversion: convert binary data file to text format, with selectable space or tab separators in addition to CSV, and selectable section, thinning available • Display format settings: scroll functions, enlarge/reduce display, display channel settings • Others: voltage value trace function, jump to cursor/trigger position function
Operating environment	Windows 2000/XP/Vista (32-bit), or Windows 7 (32-bit/64-bit)

Configuration of options Note: Options described as "factory-installed options" must be specified when ordering and cannot be installed by the user.

Input modules Input cables are not supplied. Please purchase the appropriate cable for the intended application. Install by inserting into the main unit. Can be replaced by user.

Recommended ANALOG UNIT 8956

HIGH RESOLUTION UNIT 8957
16ch SCANNER UNIT 8958
DC/RMS UNIT 8959
STRAIN UNIT 8960
HIGH VOLTAGE UNIT 8961
.....Maximum 4 units in one MEMORY HiCORDER 8861-50

ANALOG UNIT 8936
VOLTAGE/TEMP UNIT 8937
FFT ANALOG UNIT 8938
STRAIN UNIT 8939
F/V UNIT 8940
4ch ANALOG UNIT 8946
CHARGE UNIT 8947

Voltage measurement
(Voltage is limited to the specifications of the input modules in use)

Recommended

ALLIGATOR CLIP L9790-01
Red/black set attaches to the ends of the cables L9790

CONTACT PIN 9790-03
Red/black set attaches to the ends of the cables L9790

GRABBER CLIP 9790-02
Red/black set attaches to the ends of the cables L9790
* When this clip is attached to the end of the L9790, input is limited to 300 V. Red/black set.

CONNECTION CORD L9790
Flexible ϕ 4.1 mm (0.16 in) thin dia. cable allowing for up to 600 V input. 1.8 m (5.91 ft) length
* The end clip is sold separately.

L9790 **L9790-01** **9790-03** **9790-02**

CONNECTION CORD L9198
 ϕ 5.0 mm (0.20 in) dia., cable allowing for up to 300 V input. 1.7 m (5.58 ft) length, small alligator clip

10:1 PROBE 9665
Max. rated voltage to earth is same as for input module, max. input voltage 1 kV rms (up to 500 kHz), 1.5 m (4.92 ft) length

100:1 PROBE 9666
Max. rated voltage to earth is same as for input module, max. input voltage 5 kV peak (up to 1MHz), 1.5 m (4.92 ft) length

CONNECTION CORD 9197
 ϕ 5.0 mm (0.20 in) dia., cable allowing for up to 600 V input. 1.8 m (5.91 ft) length, a detachable large alligator clips are bundled

GRABBER CLIP 9243
Attaches to the tip of the Cord 9197, Red/Black set, 196 mm (7.72 in) length

High-Voltage measurement for use with the power supply

DIFFERENTIAL PROBE 9322
For up to 2 kV DC or 1 kV AC. Use with either AC Adapter 9418-15, or Probe Power Unit 9687 and Power Cord 9248.

PROBE POWER UNIT 9687
Factory-installed option - user cannot install, built in the bottom case. Simultaneously power up to 8 units of Differential Probe 9322. (Max. 3 A output)

POWER CORD 9248
To connect Differential probe 9322 and Probe power unit 9687, 70 cm (2.3 ft) length

AC ADAPTER 9418-15
For powering Differential probe 9322, 100 to 240 V AC

Printer options

RECORDING PAPER 9231
A4 width 216 mm (8.50 in) x 30 mm (98.43 in), 6 rolls

RECORDING PAPER 9234
A6 width 112 mm (4.41 in) x 18 mm (59.06 ft), 10 rolls

A4 PRINTER UNIT 8995
Factory-installed option. Either 8995 or 8995-01 printer can be installed. Printing width 200 mm (7.87 inch). Compatible recording paper: Model 9231

A6 PRINTER UNIT 8995-01
Factory-installed option. Either 8995 or 8995-01 printer can be installed. Printing width 100 mm (3.94 inch). Compatible recording paper: Model 9234

Logic signal measurement

Recommended

LOGIC PROBE 9327
4-channel type, for voltage/contact signal ON/OFF detection (response time 0.1 μ sec or higher, miniature terminal type)

LOGIC PROBE MR9321-01
4 isolated channels, ON/OFF detection of AC/DC voltage (miniature terminal type)

LOGIC PROBE 9320-01
4-channel type, for voltage/contact signal ON/OFF detection (response time 0.5 μ sec, miniature terminal type)

CONVERSION CABLE 9323
Used for connecting the 9320/9321/MR9321 and 8860 series MEMORY HiCORDERs, because the terminal shapes are different.
* This cable is not required for the small-terminal types 9327, 9320-01, 9321-01, and MR9321-01.

MEMORY HiCORDER 8860-50
* The MEMORY HiCORDER 8860-50 cannot operate alone. You must install one or more optional input modules in the unit.
* When ordering, specify one memory board for the 8860-50.

MEMORY HiCORDER 8861-50
* The MEMORY HiCORDER 8861-50 cannot operate alone. You must install one or more optional input modules in the unit.
* When ordering, specify two memory boards of the same capacity for the 8861-50.

HD UNIT 9718-50
Factory-installed option. 80 GB

MEMORY BOARD 9715-50
(32 Megaword capacity)

MEMORY BOARD 9715-51
(128 Megaword capacity)

MEMORY BOARD 9715-52
(512 Megaword capacity)

MEMORY BOARD 9715-53
(1 Gigaword capacity)

MEMORY BACKUP UNIT 9719-50
Factory-installed option. Internal type.

Note: Memory boards are not built in as a standard feature. Choose one board for Model 8860-50, and two of the same capacity for the 8861-50, for factory pre-installation.

DC POWER UNIT 9684
Factory-installed option - not user installable, built in on the bottom case. 12 V DC drive.

CLAMP ON PROBE 3273-50
DC to 50MHz wideband response, mA-class current up to 30A rms

CLAMP ON PROBE 3274
DC to 10MHz wideband response, mA-class current up to 150A rms

CLAMP ON PROBE 3275
DC to 2MHz wideband response, mA-class current up to 500A rms

CLAMP ON PROBE 3276
DC to 100MHz wideband response, mA-class current up to 30A rms

POWER SUPPLY 3272
Connect and power up to one CLAMP ON PROBE to use in combination with voltage input modules

POWER SUPPLY 3269
Connect and power up to four CLAMP ON PROBES to use in combination with voltage input modules
* Either the DC power unit 9684 or the probe power unit 9687 may be used. If you want to use both at the same time, consult us.

PROBE POWER UNIT 9687
Factory-installed option - not user installable, built in on the bottom case. Simultaneously power up to at least 5 units of Clamp on Probes 3273-50 to 3276 or Differential Probe 9322. (Actual number depends on combination of probes.)

Current measurement * To connect the clamp-on sensor via the conversion cable, the 3274, 3275, and 3276 cannot be used for the F/V UNIT 8940

F/V UNIT 8940
CONVERSION CABLE 9318 (To connect the 9272 - 9279 and the 8940)

UNIVERSAL CLAMP ON CT 9277
Observe waveforms from DC to distorted AC. DC to 100kHz response, input 20A / output 2V AC

UNIVERSAL CLAMP ON CT 9278
Observe waveforms from DC to distorted AC. DC to 100kHz response, input 200A / output 2V AC

UNIVERSAL CLAMP ON CT 9279
Observe waveforms from DC to distorted AC. DC to 20kHz response, input 500A / output 2V AC

SENSOR UNIT 9555-10
Power supply unit for the 9272 to the 9279 clamp sensors, except for connecting to the F/V UNIT 8940, for signal output L9217 is necessary.

CLAMP ON SENSOR 9272-10
Enables observation of AC current waveforms. Input: 1 to 100kHz, selectable 20 and 200A rms ranges, 2V AC output

CONVERSION CABLE 9705
Use with the Conversion Cable 9318 to connect Model 9272-10 to the F/V Unit 8940. (Not necessary for when using the Model 9272 due to different wiring specifications.)

CONVERSION CABLE 9318
To connect the 9272 to 9279 and the 8940

CONVERSION CABLE 9319
To connect the 3273-50 and the 8940
Note: cannot be used with the 3274, 3275, 3276 to connect the 8940 via this cable 9319

CLAMP ON PROBE 3273-50
DC to 50MHz wideband response, mA-class current up to 30A rms

Current measurement *Connect directly to the analog input module

3274 **3275** **3273-50** **3276** **3272** **3269**

CLAMP ON PROBE 3273-50
DC to 50MHz wideband response, mA-class current up to 30A rms

CLAMP ON PROBE 3274
DC to 10MHz wideband response, mA-class current up to 150A rms

CLAMP ON PROBE 3275
DC to 2MHz wideband response, mA-class current up to 500A rms

CLAMP ON PROBE 3276
DC to 100MHz wideband response, mA-class current up to 30A rms

POWER SUPPLY 3272
Connect and power up to one CLAMP ON PROBE to use in combination with voltage input modules

POWER SUPPLY 3269
Connect and power up to four CLAMP ON PROBES to use in combination with voltage input modules
* Either the DC power unit 9684 or the probe power unit 9687 may be used. If you want to use both at the same time, consult us.

PROBE POWER UNIT 9687
Factory-installed option - not user installable, built in on the bottom case. Simultaneously power up to at least 5 units of Clamp on Probes 3273-50 to 3276 or Differential Probe 9322. (Actual number depends on combination of probes.)

Combination example (1)

Main unit with memory 32 MW	No. of CH.	2 ch + logic 16 ch	4 ch + logic 16 ch	6 ch + logic 16 ch	8 ch + logic 16 ch
(normal choice of the input unit, up to 200V AC direct input.)	8860-50 x 1	Input module 8956 x 1	8956 x 2	8956 x 3	8956 x 4
	Memory Board 9715-50 x 1	Input cable 9198 x 2	9198 x 4	9198 x 6	9198 x 8

Combination example (2)

Main unit with memory 32 MW	No. of CH.	10 ch + logic 16 ch	12 ch + logic 16 ch	14 ch + logic 16 ch	16 ch + logic 16 ch
(normal choice of the input unit, up to 200V AC direct input.)	8861-50 x 1	Input module 8956 x 5	8956 x 6	8956 x 7	8956 x 8
	Memory Board 9715-50 x 2	Input cable 9198 x 10	9198 x 12	9198 x 14	9198 x 16

Note: Company names and Product names appearing in this catalog are trademarks or registered trademarks of various companies.

HIOKI
HIOKI E. E. CORPORATION

Headquarters :
81 Koizumi, Ueda, Nagano, 386-1192, Japan
TEL +81-268-28-0562 / FAX +81-268-28-0568
http://www.hioki.co.jp / E-mail: os-com@hioki.co.jp

HIOKI USA CORPORATION :
6 Corporate Drive, Cranbury, NJ 08512 USA
TEL +1-609-409-9109 / FAX +1-609-409-9108
http://www.hiokiusa.com / E-mail: hioki@hiokiusa.com

HIOKI (Shanghai) Sales & Trading Co., Ltd. :
1608-1610, Shanghai Times Square Office, 93 Huai Hai Zhong Road
Shanghai, P.R.China POSTCODE: 200021
TEL +86-21-63910090/63910092 FAX +86-21-63910360
http://www.hioki.cn / E-mail: info@hioki.com.cn

Beijing Office : TEL +86-10-84418761 / 84418762

Guangzhou Office : TEL +86-20-38392673 / 38392676

HIOKI INDIA PRIVATE LIMITED :
Khandela House, 24 Gulmohar Colony Indore 452 018 (M.P.), India
TEL +91-731-4223901, 4223902 FAX +91-731-4223903
http://www.hioki.in / E-mail: info@hioki.in

HIOKI SINGAPORE PTE. LTD. :
33 Ubi Avenue 3, #03-02 Vertex, Singapore 408868
TEL +65-6634-7677 FAX +65-6634-7477
E-mail: info@hioki.com.sg

DISTRIBUTED BY